

# Applications – Car body – Body components

## Table of contents

2 Body components and modules.....	2
2.1 Engine cradles and engine mounts .....	2
2.2 Suspension strut domes.....	8
2.3 Front end carriers .....	12
2.4 Cross car beam (instrument panel support) .....	13
2.5 Rear frame.....	16
2.6 Other aluminium components in the body structure .....	17

## 2 Body components and modules

Structural aluminium components and modules can be safely integrated into a steel body structure. There are different methods for joining aluminium to steel which fulfil highest requirements. However, when the integration of structural aluminium components and modules into a steel body structure is considered, solutions must be sought for two issues:

- Aluminium/steel joints have to be designed and/or properly protected to safely avoid any possibility of galvanic corrosion.
- Potential problems due to the different thermal expansion coefficients of steel and aluminium must be accounted for in the design process.

Proven and tested corrosion protection methods are readily available. The necessary precautions depend on the specific application and the selected joining technique, but when the proper measures are taken, long term performance of the assembled mixed material structure can be guaranteed.

Thermal expansion effects are of little relevance under normal service conditions. Thus, the installation of structural aluminium components and modules into the lacquered body-in-white (BIW) presents in general no problems.

More difficult is the integration of aluminium components into a steel body structure in the body shop, i.e. ahead of the lacquering operation of the BIW. In this case, it is essential to prevent (or minimize) the formation of residual internal stresses or the occurrence of geometrical distortions due to the difference in the thermal expansion coefficients of the two metals. The critical step is the temperature change during lacquer bake hardening, in particular during the hardening of the first lacquer layer of the cathodic electro-coating process which takes place in the temperature range 170 – 180 °C. As a consequence, single aluminium components are seldom integrated already into a steel BIW, but mostly attached later in the assembly plant into the already lacquered car body.

### 2.1 Engine cradles and engine mounts

The primary function of the engine cradle is to provide structural support for various subsystems of the car. It locates in particular the following components relative to the body structure:

- Powertrain assembly (i.e. the engine and transmission mounts)
- Front suspension module (lower control arms and stabilizer bar)
- Steering system.

Furthermore, it protects the powertrain components from incidental ground contact and significantly contributes to the structural rigidity and safety of the overall car body.

The engine cradle is an important structural element in the front of the vehicle and, thus, an interesting candidate for lightweighting with aluminium. Different design approaches have been evaluated. As a first example, the sheet-intensive aluminium engine cradle developed for the Ford P2000 (1998) is shown below.

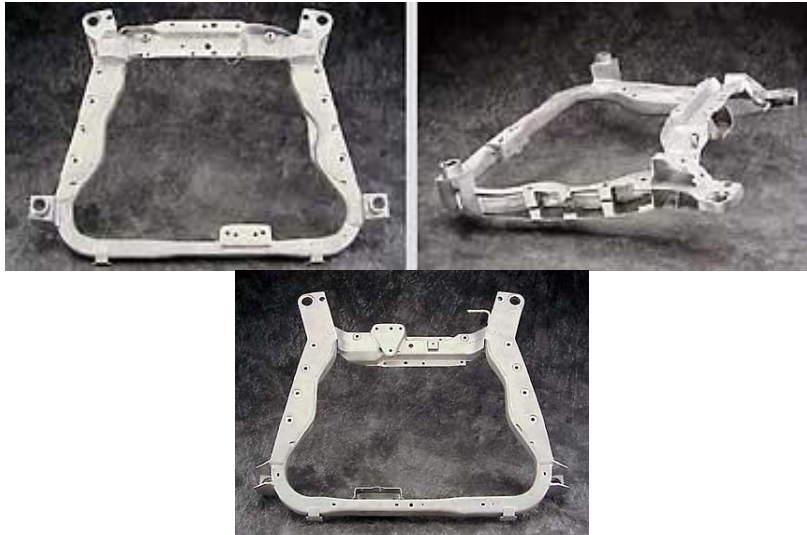

**Aluminium engine cradle developed for the Ford P2000**

The all-aluminium engine cradle shown above was assembled using two castings, a hydroformed tube and eight formed sheet parts. The weight of the aluminium assembly was 14.4 kg compared to the 21.7 kg for the original steel assembly, i.e. the weight of the engine cradle could be reduced by one third. Probably even important from a cost-efficiency point of view was the reduction of the number of parts from 21 steel parts to 11 aluminium parts.

An extrusion-based engine cradle for a midsize, front wheel drive car was developed by General Motors and produced in high volumes (300'000 units per year). The start of production was 1999. The specifications are:

- Dimensions: (L / W / H in mm): 1140 / 1190 / 230
- Finished part weight (in kg): 17.0

Compared to the steel solution, a weight reduction of 32 % was achieved (with a simultaneous increase of the stiffness). The number of parts could be reduced from 24 (steel) to 17 (aluminium).

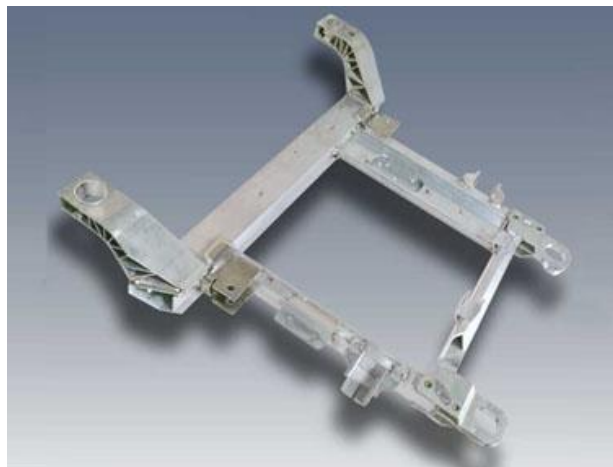

**Extrusion-based aluminium engine cradle**

## THE Aluminium Automotive MANUAL

The GM engine cradle consisted of 15 straight, machined extrusions and two small sheet stampings. The applied extrusion alloys were EN AW-6061 (in the tempers T4 and T6) and EN AW-6063-T4. The use of extrusions allowed to place the material exactly where needed; the applied wall thicknesses varied between 3.0 and 20.5 mm. The sheet material was EN AW-6061 (gauge 4.8 mm). The cradle was assembled by robotic MIG welding. First, the front module and rear module subassemblies were produced and then joined with the side rails into a square assembly. Finally, the brackets were attached.



**Extrusion-based aluminium engine cradle used for the Chevrolet Monte Carlo and Impala models**

**(Source: Magna)**



**All-aluminium assembled engine cradle**

**(Photo: A.O.Smith)**

Another example of an assembled engine cradle is shown above. It consists of 15 extruded parts, a formed sheet part and a few cover plates and demonstrates again the advantages offered by the application of the aluminium extrusion technology. An optimized extrusion-based design offers the possibility to integrate many additional functions into the structural component.

Similar possibilities, but without the need for complicated assembly operations are offered by high quality aluminium castings. Consequently, modern engine cradle design concepts rather use cast aluminium components.



**Cast engine cradle of the Mercedes-Benz S class (W220)**



**Cast aluminium engine cradle of the Mercedes-Benz C class (C204)**

**(Photo: Aluminium Rheinfelden)**

The engine cradle of the Mercedes-Benz C class is produced from the high quality casting alloy Silafont®-36 and is subjected to an age hardening treatment after casting. A specially optimized high pressure die casting process characterized by forced bleeding is applied. The component with the dimensions 920 × 580 × 170 mm weighs 10.0 kg.



**Aluminium engine cradle of the Cadillac CTS combining a large hollow casting with extrusions**

**(Photo: GM)**

## THE Aluminium Automotive MANUAL

Aluminium castings can also be combined with extrusions as for example demonstrated by the welded engine cradle Cadillac CTS. The achieved weight reduction compared to steel is about 10 kg or 35 % (combined with a drastically reduced number of parts).



**Bimetallic engine cradle with steel cross members and aluminium A356 cast over the tube ends**

**(Photo: Cosma)**

A most interesting variant of this design which also meets GM's design and performance requirements (durability, corrosion resistance, crash, etc.) has been developed by Cosma. It is a bimetallic engine cradle where steel tubes are applied instead of the aluminium extrusions. The bimetallic cradle can almost reach the low mass of an all-aluminium cradle (weight reduction 25 - 30 %), but at a lower cost.

During the casting process for the bimetallic cradle, aluminium is injected into a die which already contains the steel cross members. The process produces a mould over the tube ends. The differential in coefficient of thermal expansion between steel and aluminium creates a shrink fit at the joint. In addition, an anti-rotation feature ensures that no separation can occur between the steel and aluminium components.

The cross member shown below joins the engine to the chassis in the Porsche Panamera (weight 5.5 kg). It is a highly complex component with various fixing points for wheel mountings, cables and hoses. The cross member is produced using a coreless low pressure permanent mould casting process. Made from the alloy AlSi7Mg0,3 in the T6 temper, the part exhibits outstanding mechanical characteristics.



**Cast aluminium front cross member for the Porsche Panamera**

**(Photo: GF Automotive)**

Aluminium high pressure die castings are also used for engine mounts. Typical examples of cast aluminium engine brackets are shown below.



**Aluminium engine bracket produced by high pressure die casting**

**(Photo: Aluminium Rheinfelden)**

The bracket shown above has a weight of 1.5 kg and is produced from the alloy Silafont®-36 (AlSi9MgMn) for the BMW 6-cylinder engine N52. It is used in the as-cast state. The application of high quality aluminium casting alloys like Silafont®-36 is necessary as the brackets for modern, high-performance engines have to fulfil highest requirements with respects to dynamic loads (i.e. the cast material must show high fracture toughness).



**Other examples of cast aluminium engine brackets**

**(Photo: Aluminium Rheinfelden)**

Another example for a cast aluminium structural component is the torque cross member which stabilizes a transversally positioned engine towards the back, i.e. connects to the firewall. The high pressure die cast part weighs 2.2 kg and is produced using the alloy AISi9Cu3(Fe).



**Aluminium torque cross member for the Audi models A4 and Q5**

(Photo: GF Automotive)

### ***2.2 Suspension strut domes***

The strut dome (also strut tower or strut mount) serves multiple purposes because different components are integrated into one assembly. It is the component that attaches the suspension strut to the vehicle and provides a support for the shock absorbers and the springs. Thus the strut dome must support high static and dynamic loads; in particular in cars equipped with a MacPherson strut suspension system where the spring and the shock absorber are combined in a single unit and the entire vertical suspension load is transmitted to the top of the strut dome. In many cases, the (front) strut dome also contains a bearing or bearing plate that serves as the steering pivot.



**Early example of a suspension strut dome produced by vacuum high pressure die casting (alloy: GD-AlSi10Mg (A239))**

Due to its shape and the various functionalities, the strut dome is a component which is traditionally assembled from a number of steel parts. The substitution of a steel strut dome by a one-piece aluminium casting not only results in a significant weight reduction, but eliminates many manufacturing and assembly steps, i.e. it is also a highly cost-efficient lightweighting measure. However, since the strut dome is a highly demanding structural component, only top quality aluminium castings fulfil the application-specific requirements. The production of



the relatively large, thin-walled cast part asks for the selection of special aluminium casting alloys and tempers as well as the application of properly controlled, vacuum-assisted high pressure die casting methods. The use of vacuum-assisted high pressure die casting techniques is also a necessary pre-condition if any joining of the cast strut dome by welding is envisaged.

Optimized aluminium casting alloys and casting procedures allow the production of strut domes of more sophisticated designs. A most challenging task is the avoidance of geometrical distortions which can occur both during the cooling of the as-cast parts after removal from the die as well as during any subsequent heat treatment. An outstanding example is the strut dome produced for the BMW 5 series models with a weight of 2.0 kg (using the alloy AlMg5Si2Mn).



**Aluminium suspension strut dome for the BMW 5 series models  
(Photo: GF Automotive)**

The other aluminium casting alloy used for such applications is AlSi10MnMg. It shows outstanding flow properties and can thus be used for complex, delicate components which have to satisfy precisely defined requirements. Compared to AlMg5Si2Mn which is used in the as-cast state, this alloy has the disadvantage that the as-cast component must be heat treated to exploit its full strength potential.

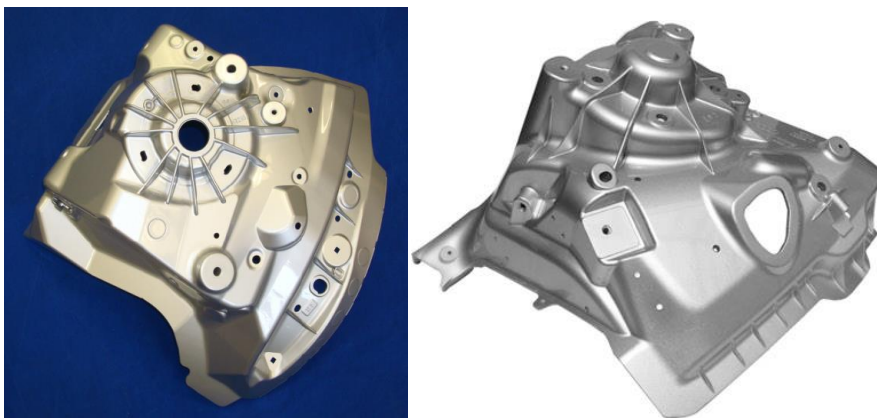

**Aluminium suspension strut dome for the BMW 5 series Gran Turismo (left) and Audi A6 / A7 (right) made from the casting alloy AlSi10MnMg  
(Photo: GF Automotive)**

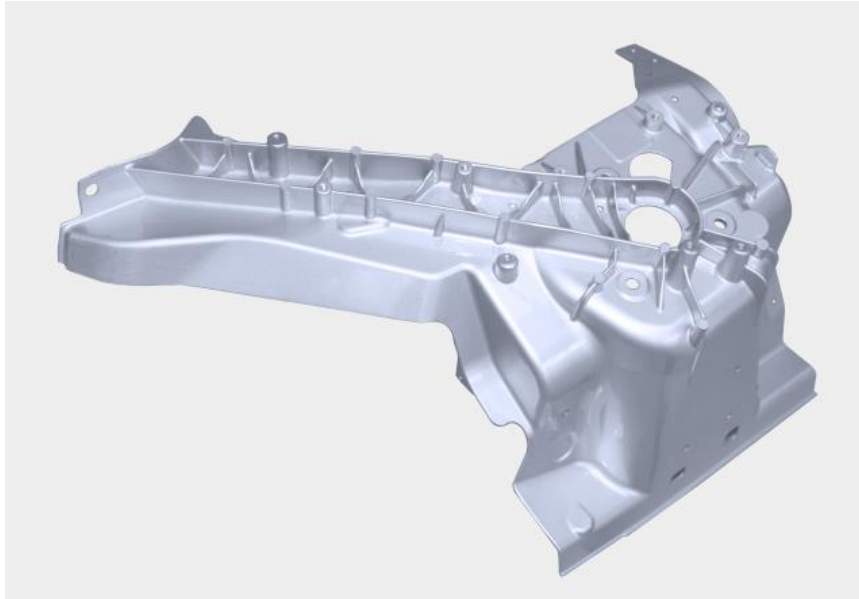

**Aluminium suspension strut dome for the Panamera (alloy: AlMg5Si2Mn)  
(Photo: GF Automotive)**

The design of the cast aluminium strut dome of the Porsche Panamera shown above with a weight of 2.7 kg includes a structure arm which connects to the A pillar for improved stiffness in the chassis.

In general terms, a strut dome in a monocoque structure is a reinforced portion of the inner wheel well and is not necessarily directly connected to the longitudinal beams. For this reason there is inherent flex within the strut towers relative to the longitudinals. In many cases, a strut bar (or torque member) is therefore introduced to reduce this strut tower flex by tying two parallel strut towers together. Aluminium castings are often used for torque cross members in order to connect the strut domes and thus increase body (and chassis) stiffness. To accomplish this effectively, the bar must be rigid throughout its length and, if possible, it should also be attached to the firewall.



**Cast aluminium strut bar  
(Photo: BMW)**

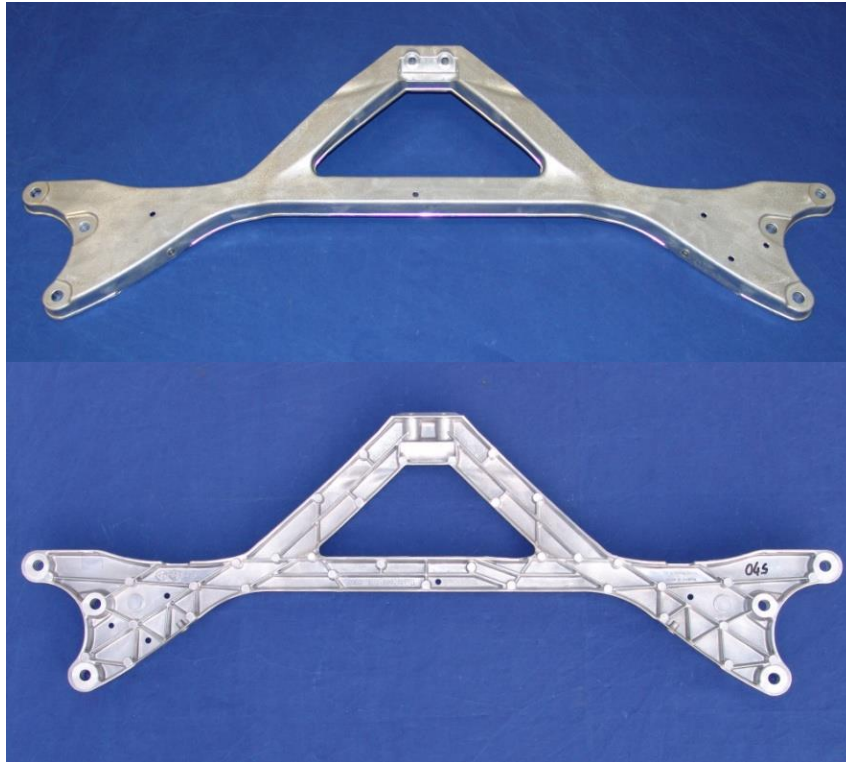

**Aluminium strut bar for the Audi A4/Q5 produced by high pressure die casting (weight: 2.2 kg)**

**(Photo: GF Automotive)**

As an alternative to cast aluminium components, also an aluminium tube can be used to connect the strut towers as demonstrated below for the Cadillac ATS.

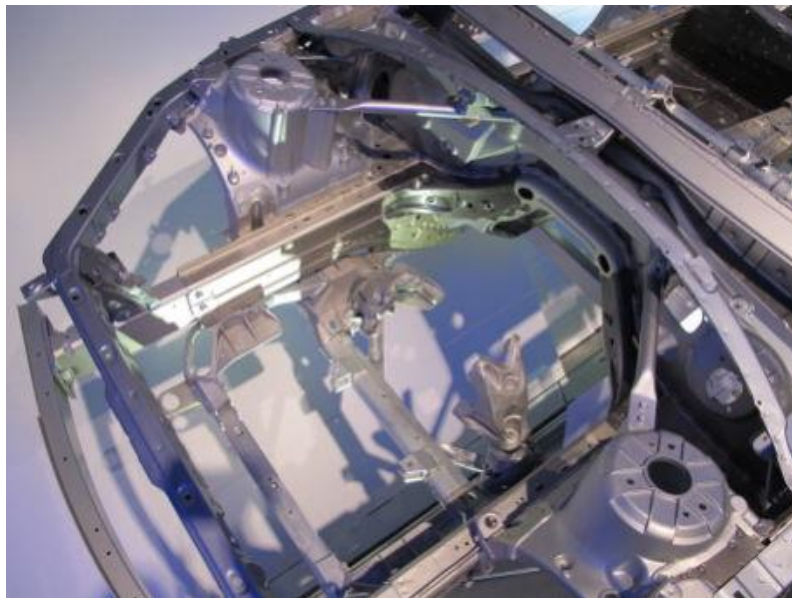

**Engine compartment of the Cadillac ATS with fully braced cast-aluminium strut towers and a fabricated aluminium engine cradle**

**(Photo: GM)**

## 2.3 Front end carriers

The front-end module is a complex assembly unit with very high functional and aesthetic demands. Behind the visible parts is the front-end carrier, a structural component which houses several important components of the vehicle's front end, e.g. the headlights, the radiator, the engine cooling fan, etc. The front end carrier is also part of the car's safety concept, both with respect to the protection of the vehicle and its occupants in a collision as well as with respect to pedestrian protection. Furthermore, it comes into contact with the engine compartment, exposing it to a wide variety of temperatures as well as debris from the road and varying weather conditions.



**Front end of the Audi A6 (C7)**

**(Photo: Faurecia)**

The front end carrier also contributes significantly to the torsion stiffness of the body structure. This is most important for convertibles. Aluminium cast parts with an appropriate rip structure efficiently ensure the required stiffness and crash worthiness. The example shown below is a high quality aluminium casting produced by the high pressure die casting method using the alloy Silafont®-36 (AlSi9MgMn) in the as-cast state.



**Front end carrier of the BMW 3 series convertible**

**(Photo: Aluminium Rheinfelden)**

Traditionally, front end carriers have been produced from steel or aluminium. In car models with a fixed roof, the metallic solutions are today more and more replaced by mixed material designs including plastics and composites. Most interesting are in particular hybrid solutions, e.g. front end carriers manufactured as a plastic-aluminium composite structure.



**Front end carrier manufactured as a plastic-aluminium composite structure for the Audi TT**

**(Photo: Faurecia/Lanxess)**

The hybrid front end carrier consists of three formed aluminium panels that are moulded around with glass fibre-reinforced Durethan® BKV 30 polyamide 6. Before, steel was always used as the metal component in composite front ends produced using the hybrid technology. Manufacturing the component with aluminium results in a significant 15 % weight saving compared to the design with steel inserts. The aluminum hybrid front end not only helps to lower the fuel consumption, it also improves the vehicle's driving characteristics because the weight reduction is achieved in front of the front axle, stabilizing the front of the car. As with all hybrid components, the design freedom offered by plastics enables many additional functions to be integrated into the front end carrier.

### ***2.4 Cross car beam (instrument panel support)***

The instrument panel support (also cockpit carrier or dash board carrier) is used for the mounting of instruments, i.e. the components of the instrument panel, the central console, the steering wheel and the airbag and knee protection. It also connects the left to the right A pillar and is therefore an important structural element.

The instrument panel support must meet stringent structural (rigidity) requirements. It is a vital safety component which must guarantee a high level of passive passenger safety in crash situations. It also plays an important role in reducing noise, vibration and harshness (NVH) including the provision of comfort features such as a low-vibration steering wheel. Another important product demand is weight reduction. Compared to steel instrument panel supports, an aluminium instrument panel generally achieves a weight reduction of about 40 %.

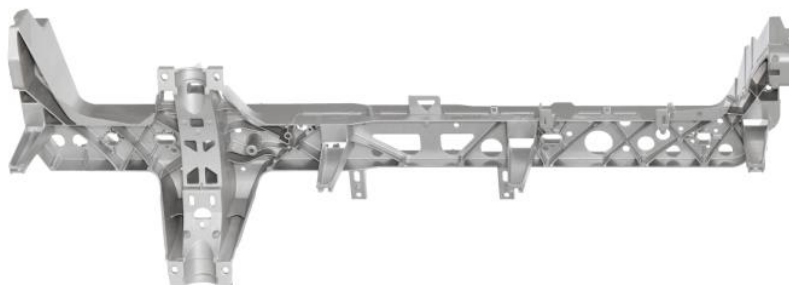

**Cast aluminium cross car beam**

**(Photo: GF Automotive)**

Aluminium instrument panel supports are produced in different design variants. However, in practice, cast magnesium components are important competitors to aluminium instrument panel supports. Large magnesium die castings can be produced with lower wall thicknesses than aluminium die castings. Thus one-piece high pressure die cast magnesium cross car beams offer in many cases more cost-effective solutions and an additional weight reduction.

But there are also interesting solutions for aluminium instrument panel supports made from wrought alloys.



**Extruded instrument panel support  
(Photo: SAPA Aluminium)**

The support beam for the instrument panel shown above was produced up to 2005 for the Iveco Daily 2000. The extruded profile (alloy ENAW-6063) was bent and the various holes were punched. The beam was then heat treated and finally some fasteners (blind rivet nuts) were assembled. Steel brackets and support struts were later mounted to the beam by use of self piercing rivets.

Close co-operation between the OEM and the supplier allows the realization of completely new aluminium concepts. As an example, a lightweight aluminium solution was developed for high volume production (annual production volume > 1 million components):

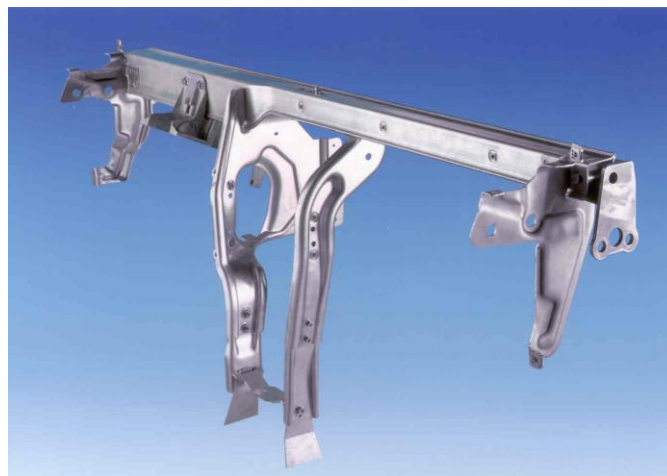

**All-aluminium instrument support which was produced for the VW PQ24 platform  
(Photo: Constellium)**

The shown all-aluminium instrument panel was used in the SKODA Fabia, VW Polo and SEAT Ibiza models and weighted just 3.9 kg. It consists of sheet metal stampings, extruded profiles, die-cast and forged parts and fulfils all of the customers' requirements in terms of both cost and technology. The main component is the transverse beam consisting of two stamped sheet half shells of the alloy EN AW-5754 with already integrated fastening elements. The beam is joined by non-vacuum electron beam welding, a high speed welding technique which guarantees top quality welds with well rounded corners. In addition, other aluminium sheet stampings are attached. The beam is fixed to the A pillar using a forged aluminium part at the driver side. Due to the different loads, a die cast element can accommodate the forces at the passenger side.

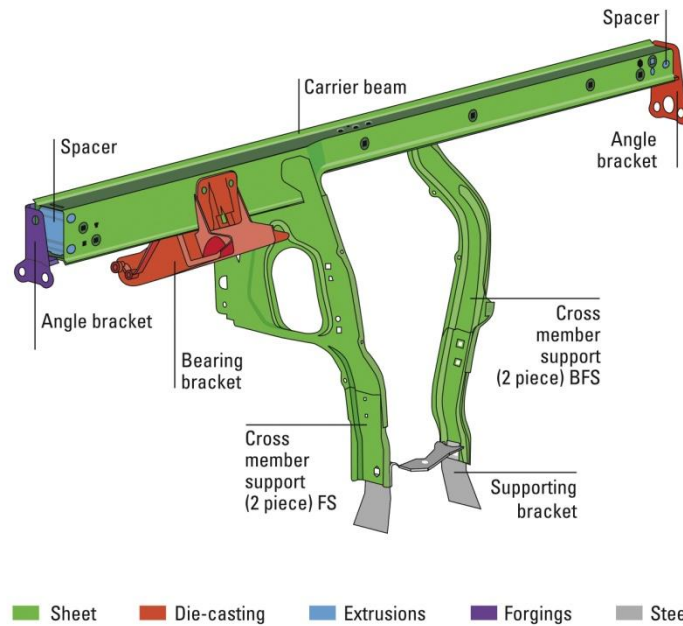

### Aluminium product forms used in the instrument panel support for the VW PQ24 platform

(Source: Constellium)

A further development represents the cockpit carrier for the current Audi A6/A7 (C7) models, a very cost-effective solution which only weighs 3.5 kg (with fasteners). The cockpit carrier consists of 21 stamped aluminium sheet parts (mainly EN AW-5754) and two small extruded parts. The four half shells are joined by electron beam welding; for the final assembly, the MIG welding technology is used.

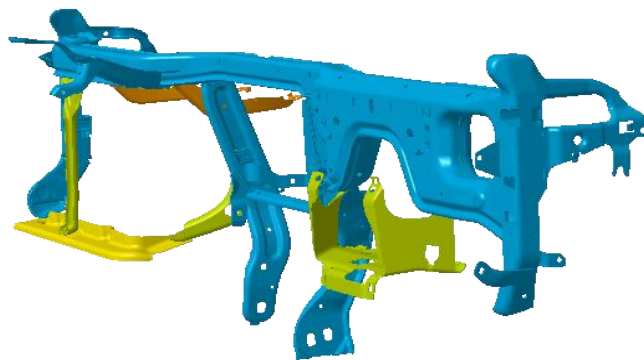

### Aluminium cockpit carrier for the Audi A6/A7 (C7)

(Source: Constellium)

Another lightweight solution designed for medium production volumes is shown below. The main element is an extruded aluminium beam (EN AW-6060) where the additional components are attached by bolting allowing easy assembly and compensation of different geometrical tolerances. The attached parts which connect to the A pillar and to the centre console are magnesium castings (made from the alloys AM50 and AM60). Also included is the air bag housing on the passenger side which is an aluminium extrusion. Instead of 6.6 kg, the instrument panel support now weighs just 4 kg.



**Instrument panel support for the Mercedes-Benz A class model**

**(Photo: Constellium)**

### **2.5 Rear frame**

In the Corvette ZR-1/LT-1 (C5), the rear frame (which supports the spare wheel and the fuel tank) was assembled using aluminium extrusions of the alloys EN AW-6061 and EN AW-6063. The structural module was assembled by MIG welding using 15 straight and 4 bent extrusions.





**Comparison between the old, steel sheet-based frame and the aluminium extrusion design (left) and detail of the aluminium rear frame (right)**

## ***2.6 Other aluminium components in the body structure***

A range of additional individual aluminium parts may be applied advantageously also for various other components in a mixed design with a steel car body structure. The application of aluminium is particularly suited particular for parts which have stiffening rather than strengthening functions.

Some examples of innovative aluminium designs are shown in the following. Aluminium panels can be used for example for the floor structure, the spare wheel recess and also internal dividing walls, e.g. the fire wall or the bulkhead. Such aluminium-alloy components which primarily define the passenger cabin or the luggage compartment can be easily riveted or bonded to the rest of the car's structure



**Trunk recess of the Mercedes-Benz SL (R231) (alloy EN AW-6016)**

**(Photo: AMAG)**

The trunk (spare wheel) recess shown above is made from a so-called "AMAG Green Alu" sheet which is produced using a rolling ingot with a recycled metal content in excess of 90%. The technical challenge involving the use of an aluminium alloy made from recycled material is to meet the high demands in terms of formability both during processing as well as with regard to crash characteristics.

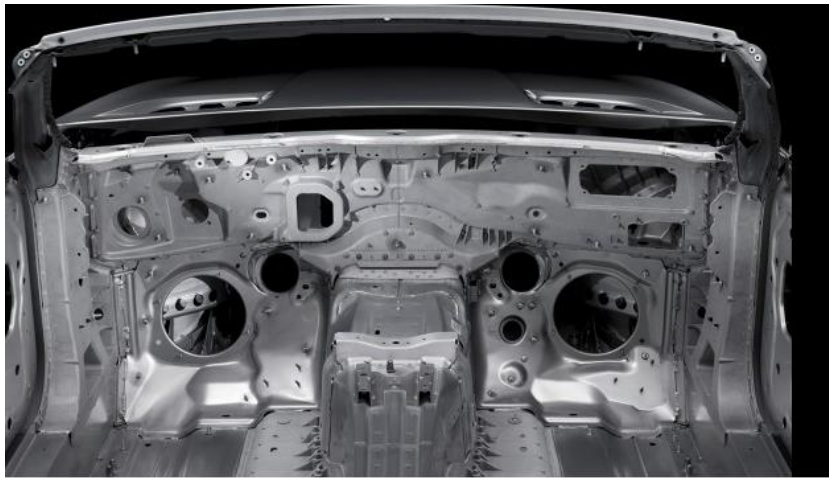

**Aluminium firewall of the Mercedes-Benz SL (R231)**

**(Photo: Daimler)**

For more complicated shaped parts, also the application of aluminium high pressure die castings can be considered. This option is most interesting when the design also offers the integration of additional functions and a reduction of the number of parts (saving of assembly cost due to part integration). The firewall shown above is at present the largest aluminium cast component made in large series for vehicle bodywork.

Higher strength aluminium alloys are required when the application of sheet components in structurally relevant areas is considered.

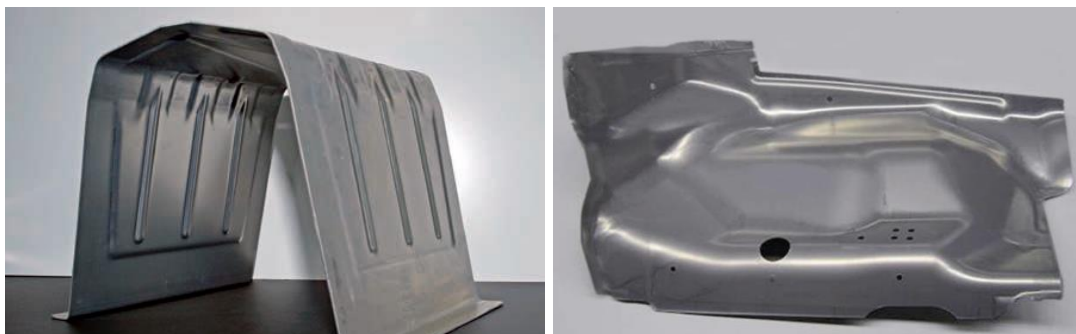

**Floor structure of the Audi A8 (D4) made from Novelis Fusion™-AS250  
(Photo: Novelis)**

An interesting development represents the floor structure of the current Audi A8 model which is made from the multi-layer Novelis Fusion™-AS250 aluminium sheet alloy with a yield strength ( $R_{p0.2}$ ) of 250 MPa. The application of the innovative multi-layer, high strength material enabled a reduction of the weight of the floor structure by 25 % compared to the earlier aluminium design. The core material of Novelis Fusion™-AS250 aluminium sheets corresponds to the alloy EN AW-6111 with a slightly lower Cu content, the surface sheets are made from Anticorodal®-170. This alloy combination results in a multi-layer material showing high strength and good formability, excellent crash energy absorption capacity and corrosion resistance.



**Tunnel of the Mercedes-Benz SL (R231) made using a tailor-welded blank  
(Photo: Novelis)**

Another innovative solution is used for the tunnel of the current Mercedes SL (R231). As an essential element of the floor structure in a rear-wheel drive car, the design and mechanical characteristics of the tunnel significantly determine the rigidity and the crash performance of the vehicle, in particular in case of a roadster. By using a tailored welded blank, it is possible to closely adapt the local material thickness to the forces exerted on the component under various loading conditions. The tailored welded blank consists of three different blanks of the AlMgSi alloy Anticorodal®-300 (EN-AW 6014), with the thicknesses 1.25 mm, 1.5 mm, and 2.0 mm for the centre blank. The alloy Ac-300 was specifically developed for automotive structural body applications with high crash performance requirements. After the coils are rolled to the required thickness, the material is solution heat treated and rapidly quenched (T4 temper). The single blanks are then cut on an automatic laser cutting line and joined by friction stir welding, a special technology that allows the manufacturing of tailored welded blanks with excellent forming properties.

The alloy Anticorodal®-300 can be also advantageously used for the front longitudinal beam. The formability requirements for the production of this component are somewhat relaxed, i.e. it is possible to apply the material in the age hardened T61 temper. Thus it is possible to realize 20 % weight reduction compared to the equivalent part in the traditionally used alloy EN AW-5754 (or approx. 6 kg per vehicle).



**Application of the alloy Anticorodal®-300 in T61 temper in the Range Rover (L405)  
(Photo: Land Rover)**

A further option is the application of ultra-high strength aluminium sheet alloys (with strength levels around 400 MPa or more). Such alloys of the AlZnMg(Cu) alloy system are most interesting materials for the construction of the rigid passenger cabin ("safety cage"). Warm forming in the temperature range 350°C allows the production of intricately shaped panels using alloys from the EN AW-7xxx series such as for example the B pillar shown below.



**B pillar made using a 7xxx series ultra-high strength aluminium alloy  
(Photo: Aleris)**

Apart from sheet panels, also aluminium extrusions and castings can be used for safety-critical applications. The high torsional rigidity of aluminium is further enhanced when a multi-cell extrusion is used. Multi-cell extrusions with inner reinforcements greatly increase both the strength and rigidity of the resulting structural part. A most interesting option is the use of multi-cell extrusions for door sills and longitudinal beams. Properly designed and machined multi-hole cross sections enable the realization of a stiff body structure with outstanding crash energy performance in both front and side impact situations.

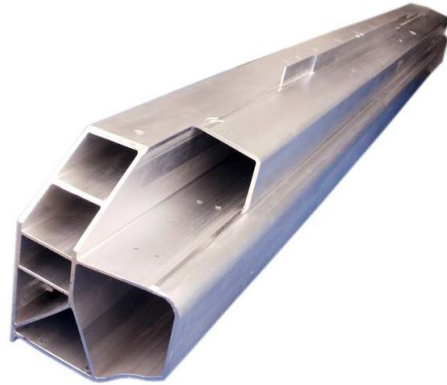

**Door sill made using an AlMgSi extrusion, used in the Mercedes-Benz SL (R231)  
(Photo: Martinrea Honsel)**



**Rear longitudinal set for the Mercedes-Benz SL (R231) (extrusion alloy: EN AW-6106)  
(Photo: Constellium)**

Also welded assemblies, e.g. using attachments made from aluminium sheets, are possible.

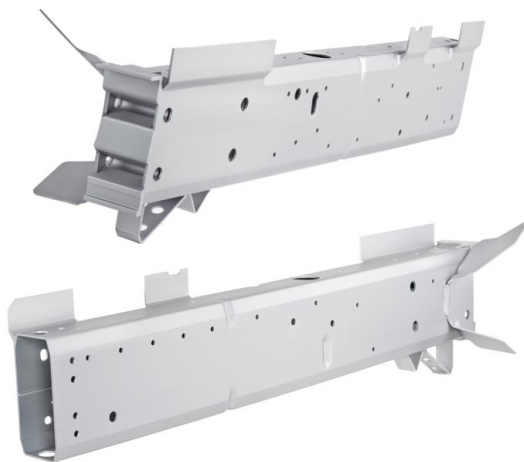

**Front longitudinal member for the Jaguar XK & F type model (EN AW-6014 extrusion  
with a welded attachment made from EN AW-5754)  
(Photo: Constellium)**



**B post outer set for the Jaguar XK & F type model (EN AW-6014 extrusion and EN AW-5754 attachment)**

**(Photo: Constellium)**

In addition, aluminium extruded sections can be used as a protecting (and structural) element in the door opening.



**Extruded aluminium door sill cover (alloy EN AW-6063)**

**(Photo: Otto Fuchs)**

Multi-cell extruded profiles are also highly suited for the production of a stiff floor. The floor structure panel shown below is an extremely stiff extrusion design for a roadster where three individual aluminium extrusions are joined by friction stir welding.

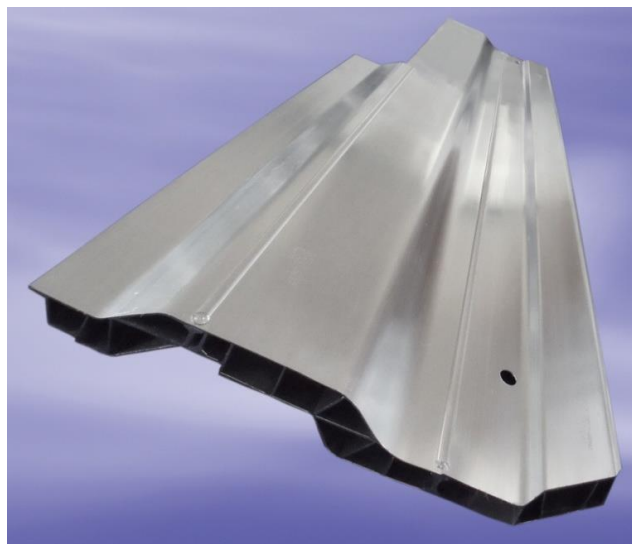

**Floor structure panel for the Mercedes-Benz SL (R 231)**

**(Photo: Martinrea Honsel)**

Other structural applications for fabricated (formed and/or machined) aluminium extrusions include for example floor cross members, roof members, etc.



**Extruded tunnel member for the Porsche 9x1 (alloy: EN AW-6106)  
(Photo: Constellium)**



**Fabricated upper A post for the Audi R8, made using the extrusion alloy: EN AW-6106  
(Photo: Constellium)**

Also cast aluminium components, produced using different high quality casting processes, are highly suitable for structural body applications. Two examples are shown below:

- a front longitudinal member (weight of 5.0 kg), produced by high pressure die casting,
- a rear longitudinal frame produced by low pressure die casting.

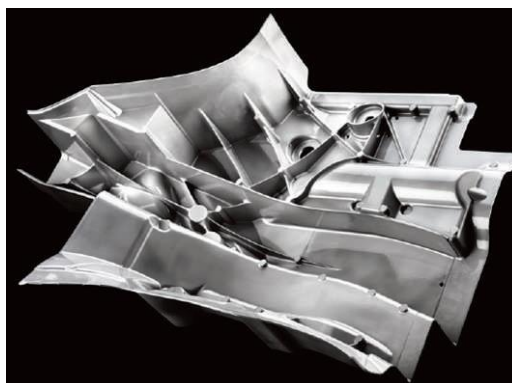

**Cast front aluminium longitudinal member for the Audi A8 (alloy AlSi10MgMnSr)  
(Photo: GF Automotive)**

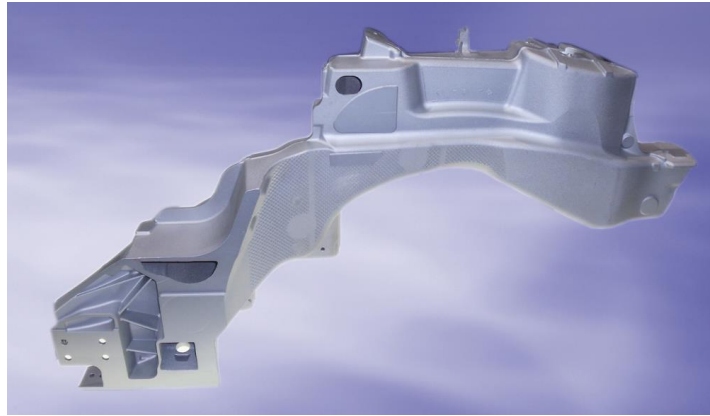

**Cast aluminium rear longitudinal frame of the Mercedes-Benz SL (R 231)**

**(Photo: Martinrea Honsel)**

The rear longitudinal frame is a large component (dimensions 1120 mm x 585 mm x 360 mm) with a weight of only 14 kg. It is a hollow structure, realized with sand cores. The closely controlled, turbulence-free filling process leads to a fine, pore-free cast structure. The required mechanical properties, in particular a high elongation to fracture (> 12 %), are achieved by a thermal treatment.