

## Design – Design for functional performance

### **Table of Contents**

3	Design for functional performance.....	2
3.1	Introduction .....	2
3.2	Crash performance .....	4
3.2.1	Introduction .....	4
3.2.2	Design for crash performance.....	5
3.2.3	Crash box design: Folding of rectangular crash boxes.....	9
3.2.4	Crash box design: Folding of circular crash boxes.....	12
3.2.5	Crash simulation with FEM.....	14
3.2.6	Failure criteria.....	15
3.2.7	Pedestrian safety .....	23
3.3	Fatigue .....	26
3.3.1	Introduction .....	26
3.3.2	Design Philosophies .....	29
3.3.3	Product development methodology .....	30
3.4	Corrosion.....	37
3.4.1	Introduction .....	37
3.4.2	Cosmetic corrosion.....	39
3.4.3	Intergranular corrosion.....	41
3.4.4	Crevice corrosion .....	44
3.4.5	Galvanic corrosion .....	46
3.4.6	General guidelines on the corrosion behaviour of aluminium .....	50

## 3 Design for functional performance

### 3.1 Introduction

Material substitution as such leads only very seldom to cost efficient solutions. The specific requirements on an automobile as defined by the different stakeholders can only be satisfied by an integrated approach. It is most important to consider the total system consisting of material development, design optimization and fabrication technology. Technically and economically promising concepts are the result of aluminium-oriented design and the application of fabrication technologies properly adapted to the material.

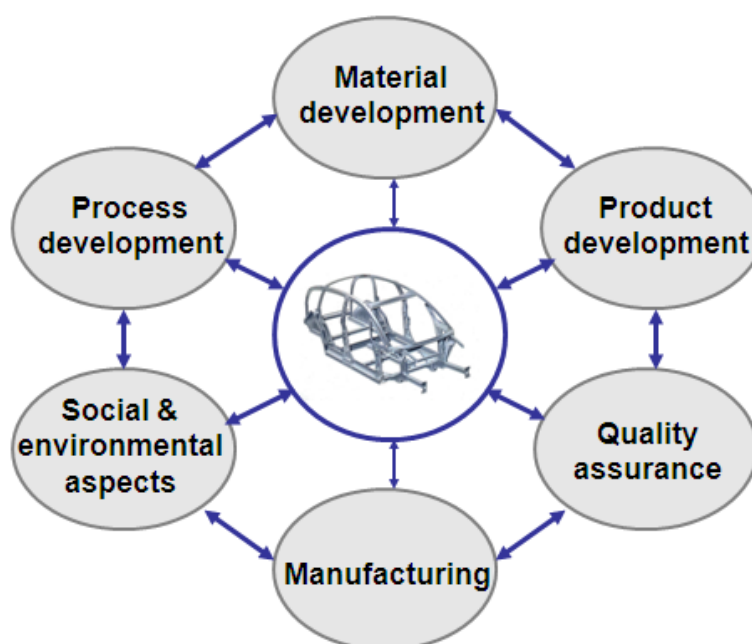

#### Development of a cost-efficient solution requires an integrated approach

Functional performance means that all the various requirements on a structural component of an automobile are fulfilled. Special attention must be given to the safety requirements, but also the packaging aspects play an important role in lightweight automotive design.

Chapter 3 provides some basic guidelines for automotive design with aluminium. In the present chapter 4, the functional performance of aluminium structures and components will be considered in more details. Chapter 5 will conclude with a specific focus on cost aspects.

While the application of aluminium alloys and products for automotive structures is nowadays well established in many car models, their performance under situations of crash, fatigue and corrosion still raises some doubts in parts of the automotive engineering community. On the other hand, the long term experience with all-aluminium and partial aluminium car body structures proves without doubt that properly designed car body structures fulfil all production and service requirements. Designing aluminium structures and components for optimum and predictable performance during service asks for specific knowledge and experience about

- the structural stiffness, stability and fatigue behaviour of structural components (e.g. hollow sections) and assembled structures,
- the crash behaviour (energy absorption and failure mechanisms) of structural components and modules, and
- the corrosion performance of aluminium alloy structures as well as that of mixed material designs.

## THE Aluminium Automotive MANUAL

An important aspect is also the existence of physical models and reliable data as well as failure criteria for numerical simulation.

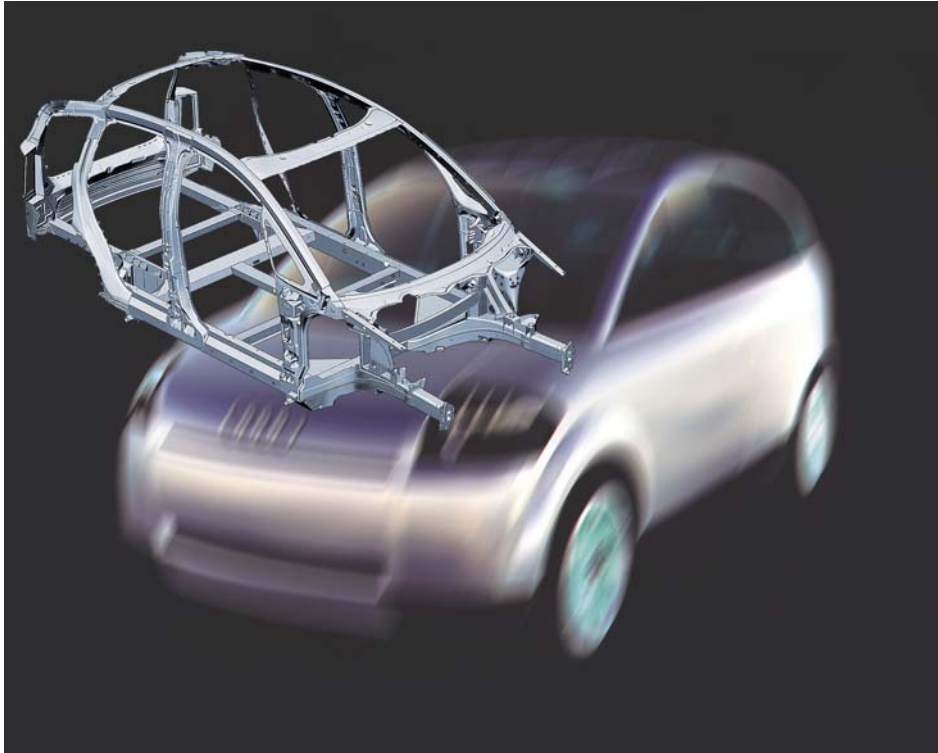

**Audi A2 – Body structure**  
**Source: Novelis**

## 3.2 Crash performance

### 3.2.1 Introduction

As far as crash protection is concerned, cars can be viewed as a combination of two important elements:

- the car front, whose first priority is to dampen the effect of the impact, i.e. it must absorb kinetic energy by deformation; and
- the safety cage, whose main role is to protect the occupants, i.e. the passenger cabin must be able to resist to the high crash forces with no/little deformation.

In order to protect a passenger effectively against fatal injury during a collision, the passenger compartment must be designed and built as rigid as possible to ensure that passengers are offered a survival space and not crushed by the collapsing body structure.

A vehicle's collapsible zone must therefore be designed to be weaker than the structure of the passenger compartment. During a collision, this guarantees that the collapsible front structure deforms in a controlled manner without premature failure before the stiff and strong structure passenger compartment is damaged.

The deformation force also determines the deceleration of the vehicle and thus the deceleration of its occupants. Deceleration in turn determines the forces acting upon the occupants via the safety belts or the airbag. This results in a further significant limitation of the maximum possible deformation force, as ultimately these forces determine the type of injury the occupants suffer, which means there are clearly defined upper limits for the maximum permissible deformation force.

Equally, the total deformation, which is determined by the length of the collapsible zone, is not freely selectable either. Here, the desired outer vehicle dimensions and other design-related boundary conditions, as well as the stipulations of designers, impose strict limits.



**Standardized tests are used to evaluate the crash performance of a car model**

**Source: EURO NCAP**

In practice, depending on the car speed at impact, priority is placed on different crash protection measures:

- at low speeds up to 15 km/h, the main goal is to minimize the repair costs;

## THE Aluminium Automotive MANUAL

- at speeds between 15 and 40 km/h, the first aim is to protect more fragile collision partners (e.g. pedestrians); and
- at high speeds (over 40 km/h), the most important concern is to guarantee occupant protection.

The specific characteristics of aluminium alloys offer the possibility to design cost-effective lightweight structures both with high stiffness as well as excellent crash energy absorption potential. Consequently, appropriate aluminium protection systems can be proposed for low and high speed impacts. As a consequence, aluminium is a preferred material to ensure the safety of a vehicle and its occupants fulfilling also related requirements such as pedestrian protection, low repair costs, etc. Applications range from aluminium side impact beams, pedestrian protection systems, bumper beams including crash boxes to complete body structures.

In the design of aluminium crash management systems, various legislative regulations and insurance test procedures have to be considered. Furthermore there are regionally different test procedures, i.e. for the performance of a bumper system in North America and in Europe. Additional demands may be also defined by the respective car producers. The variety of requirements will generally lead to the selection of different design solutions when the technically feasible alternatives are evaluated under the overall condition of cost effectiveness.

### 3.2.2 Design for crash performance

The application of aluminium enables the realization of interesting solutions for the design of lightweight crash management systems.

#### Crashworthy aluminium products

The crashworthiness of aluminium in crash relevant components or structures has been extensively demonstrated for sheet, extruded, forged and cast products in body and chassis applications. Most important is the selection of proper aluminium materials, i.e. alloy compositions and tempers which have been developed for optimum crash performance. A key requirement is that the applied material exhibits a high energy absorption capacity and deforms well under crash loads, i.e. it is important that it folds without the formations of cracks and does not tend to fragmentation during fracture.

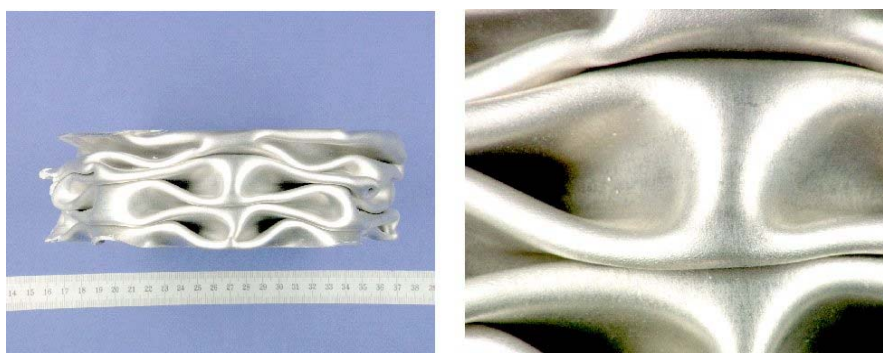

**Deformation of a longitudinally welded tube made from an aluminium sheet alloy optimized for optimum high energy absorption (Anticorodal<sup>®</sup> -300)**

**Source: Novelis**

An important parameter determining the crashworthiness of an aluminium alloy is their temper. In this context, always the temper of an alloy in a structural body component under

## THE Aluminium Automotive MANUAL

service conditions must be considered, i.e. after different degrees of deformation and the heat treatment due to the lacquer bake hardening of the body-in-white. Typical true stress-strain curves for the extrusion alloy AA6014 are shown below in three different tempers.

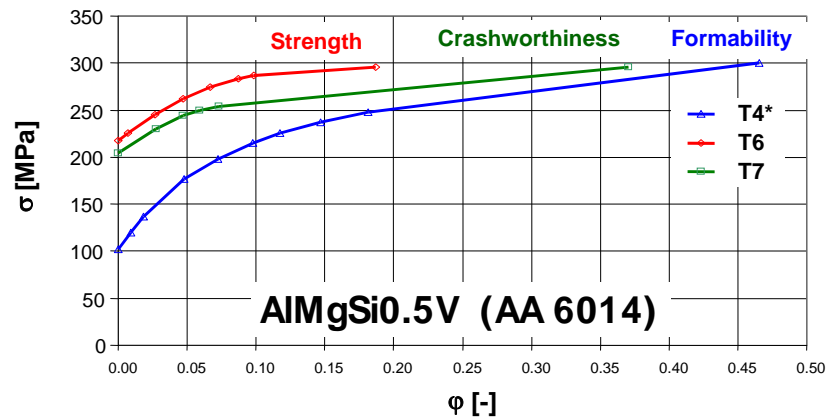

**True stress-strain curves for AA 6014, an extrusion alloy often used in automotive structures**

In the T4 temper which can be produced by rapid quenching after extrusion, formability is highest. However, this temper (or the stabilized T4\* temper) is not present in a car under service condition since the lacquer bake hardening treatment of the body-in-white changes to an underaged temper. Highest strength is achieved in the T6 temper (fully age hardened). For optimum crash performance, the formed and pre-assembled components are generally annealed at temperatures  $\geq 180^\circ\text{C}$  to an overaged temper T7. In this case, the subsequent lacquer bake hardening treatment has no additional effect.



**Deformation of an optimized extrusion alloy under axial crash loads**

Apart from wrought aluminium alloy products, also selected high quality aluminium castings are suitable for applications subjected to crash loads. A key pre-condition is the selection of an appropriate casting process, e.g. a vacuum-assisted high pressure die casting technology. Excellent castability of the alloy and no tendency for hot cracking are a must as well as the possibility to join the part either thermally or mechanically to the other car body materials. In addition, a relatively high solidification rate is necessary to ensure a fine and homogeneous microstructure within the part.

In principle, reaching the mechanical properties in the as-cast state (F temper) is desired, because a full heat treatment (T6) of the as-cast component means higher cost, lower productivity and the danger of blister and distortion of the cast part during quenching. From this point of view, the naturally hard casting alloys of the aluminium-magnesium system, e.g. Magsimal-59 ( $AlMg5Si2Mn$ ) and Magsimal-22 ( $AlMg3MnCo$ ), are most interesting as they offer sufficient strength and high ductility already in the as-cast state.



**Deformed assembly of Laser - MIG welded high quality pressure die castings made from an AlSi casting alloy optimized for crash performance**

The other option are alloys based on the binary aluminium-silicon system with a silicon level close to the eutectic point in order to achieve the fluidity and die-filling capability necessary for producing thin-walled complex shapes with large surface areas. Compared with the usual pressure die casting alloys, the AlSi alloys optimized for crash-relevant parts contain less iron (which is largely replaced by manganese to prevent extensive die sticking). The selected Mn/Fe ratio results in a fine and uniform dispersion of the quaternary AlFeMnSi phase and prevents the formation of brittle needles of the AlFeSi phase.

However, in order to ensure high ductility and good crashworthiness, AlSi casting alloys have to be heat treated at high temperatures to allow the globularization of the eutectic silicon. The usual practice of annealing at about 500°C with rapid quenching in water to room temperature would lead to heavy distortion of the thin-walled parts. Therefore it is necessary to apply a special partial solution heat treatment with subsequent air-quenching to keep the distortion within acceptable limits.

### **Special opportunities offered by the aluminium extrusion technology**



**Extruded profiles with integrated functional elements allow the realization of new, innovative crash-relevant structures**

## THE Aluminium Automotive MANUAL

Crashworthy aluminium structural components and modules are the result of a total systems approach taking into account the benefits achieved by specifically developed alloy qualities, design concepts and appropriate fabrication methods. Cost-efficient aluminium component production processes include in particular the extrusion technology. Extruded aluminium profiles can be produced in a wide variety of cross sections and can be reliably joined by various methods. Furthermore, extruded aluminium components can be easily combined with other aluminium product forms as well as with steel or other materials to form complete structural modules. Because of the low cost of the extrusion tools and the small lead times for tool manufacturing, the resulting crash management solutions are highly flexible and enable fast and simple modifications to adjust for specific crash conditions reducing both development times and costs.

The advantages of the extrusion technology proved to be a decisive factor to achieve the current, fairly strong market penetration of aluminium crash management systems. The unique potential of extruded aluminium sections is based on the following characteristics:

- Properly designed multi-chamber cross sections ensure closely controlled energy absorption characteristics.
- Multi-wall profiles offer high redundancy if a wall fails in a crash (most important to maintain the envisaged crash behaviour also in non-standard crash situations).
- Profile cross sections with customized wall thickness distribution allow the application of thicker walls only where required and thus offer additional lightweighting potential.

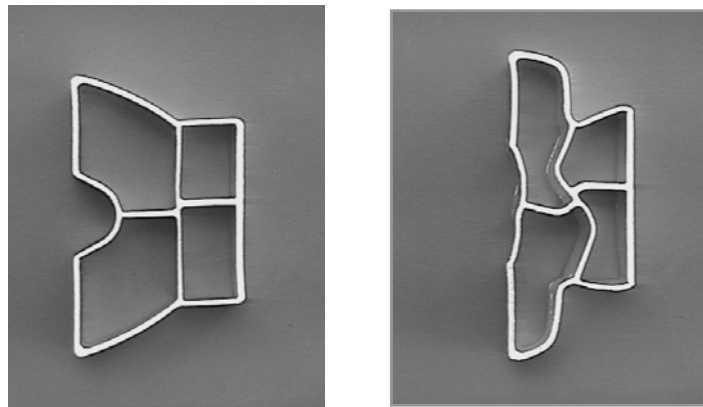

**Multi-chamber aluminum profiles with an appropriate cross section design for optimum crash absorption characteristics**

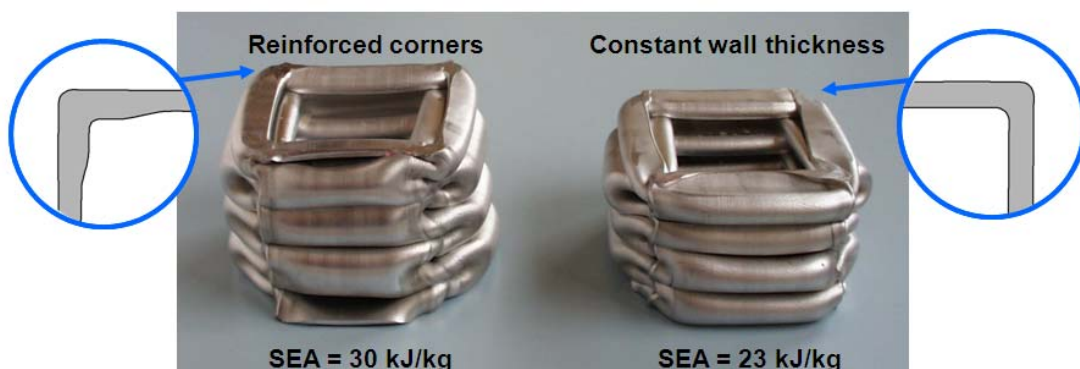

**Extruded sections with reinforced corners offer a significantly higher specific energy absorption in axial crush**



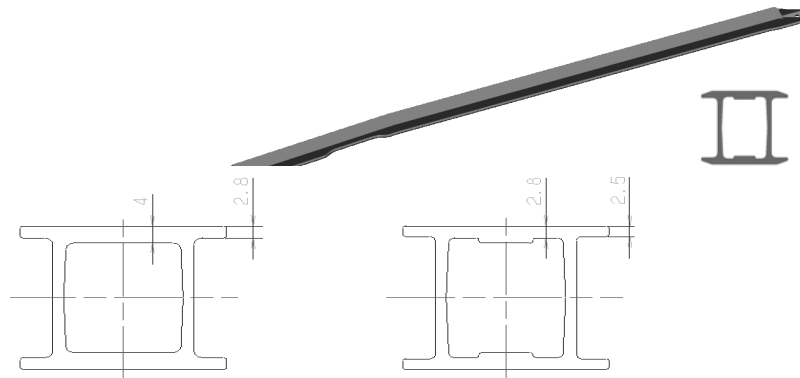

**Side impact beam with a load-optimized cross section optimized for minimum weight**

Some examples for crash box design and failure calculations are presented in subsequent chapters.

### 3.2.3 Crash box design: Folding of rectangular crash boxes

Traditional crash boxes absorb energy during axial compressive loading by a progressive folding deformation. A rectangular energy absorbing component can experience a number of failure modes. The desired failure mode is regular folding. This mode is characterized by the stable collapse of the member and the formation of regular folds throughout the axial crush loading. Such a progressive formation of regular folds absorbs energy in a consistent and controlled manner.

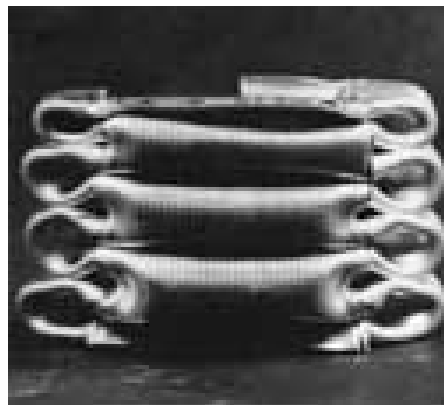

**Fully crushed rectangular crash box**

The load-deflection curves for this mode exhibit consistent secondary peaks and wavelengths:

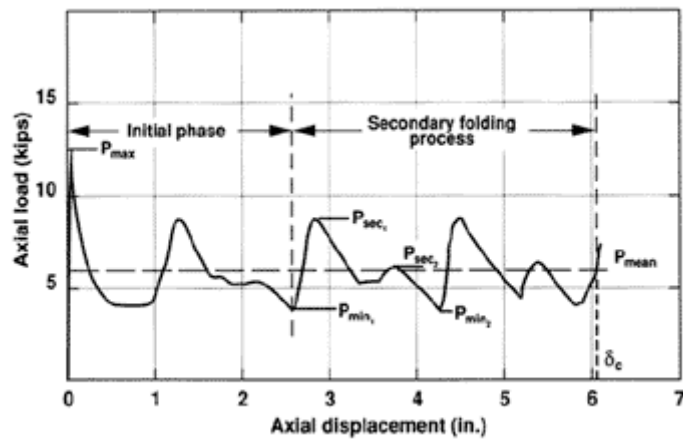

**Typical load-deflection curve for a compact rectangular section**

Other (undesirable) failure modes should be prevented through a proper geometrical design and a suitable selection of the material properties. These undesirable failure modes are:

- **Irregular folding:** The cross section does not buckle as a whole. Instead, individual walls experience local plate buckling at different loads and times during the crush event. Therefore, no regular folding pattern is obtained and the load-deflection curves do not exhibit consistent secondary peaks and wavelengths.
- **Bending collapse due to aspect ratio:** After the formation of the first fold, the folds in opposite walls interfere, preventing the formation of further folds. This forces the member into bending.
- **Bending collapse due to length:** Bending collapse can occur in the already in the deformed geometry (Euler buckling) or after the member has started to deform (partial crush buckling).

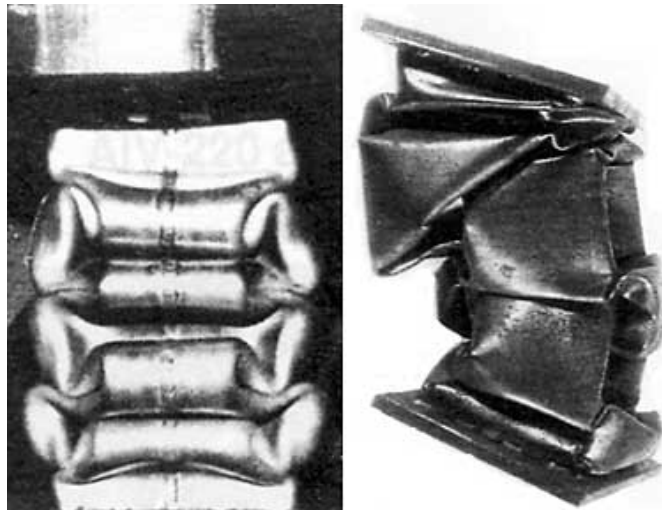

**Regular folding (left) vs. irregular folding (right)**

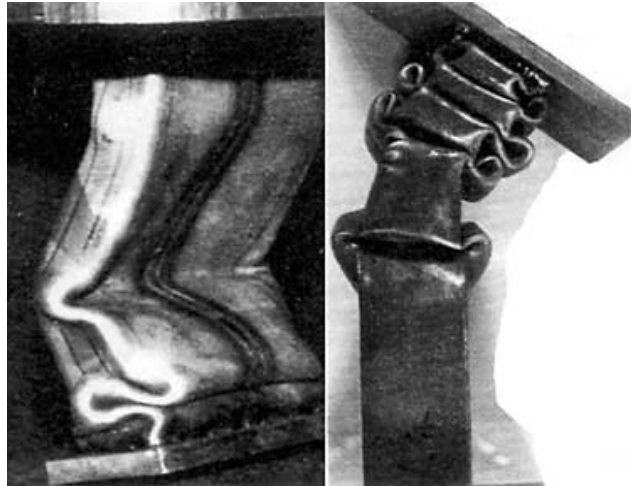

**Bending collapse due to fold interference (left) vs. bending collapse due to length (right)**

In order to obtain a predictable behaviour in energy absorbing rectangular members, the following criteria must be met:

- The section should be "compact". In a compact section, each individual wall is supported by its connecting walls such that the entire cross section buckles as a whole, at the same load and time during the crush event.
- The shorter wall (d) of the cross section must be long enough to fit the half wavelength of the fold.
- The length of the member must be less than the critical length for Euler buckling and partial crush buckling.

### 3.2.4 Crash box design: Folding of circular crash boxes

Circular sections subjected to axial compressive loads have two modes of failure that offer an acceptable energy absorption capacity and show load-deflection curves with consistent, repeating fold patterns:

- the concertina (axisymmetric) folding mode and
- the diamond folding mode.

In the axisymmetric concertina mode, rows of concentric outward facing folds are formed. The diamond failure mode is shown in the right figure. Circular sections often exhibit mixed-mode failures in which the sections begins folding axisymmetrically, and then changes to the diamond mode folding.



Axisymmetric (left) and diamond (right) folding pattern for circular crash boxes

Many equations for estimating the energy absorbing characteristics of circular sections are available in the literature.

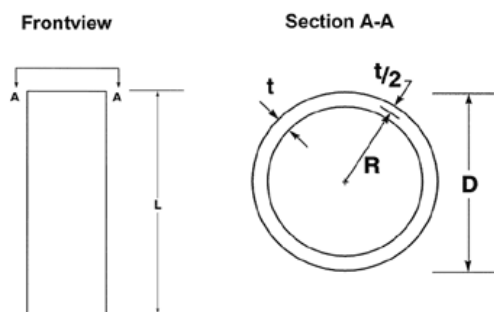

#### Geometric parameters of circular crash boxes

The following equation has been found to estimate loads for AlMgSi (6xxx) aluminium alloys fairly well:

$$P_{\text{mean}} = 2\pi t^{1.5} (0.0115rE\sigma_{\psi})^{0.5} \quad ($$

where  $P_{\text{mean}}$  = mean load [N],  
 $t$  = average wall thickness [mm],  
 $r$  = circle radius (at mid-wall thickness) [mm],  
 $E$  = Young's modulus of elasticity (71 GPa for aluminium),  
 $\sigma_{\psi}$  = yield strength ( $R_{p0.2}$ ) of material [MPa].

## Buckle initiators in folding crash boxes

Unless a severe imperfection or buckle initiator is present, the load necessary to initiate a folding of a crash box is always significantly higher than the loads associated with the formation of secondary folds. Such an initial high load ( $P_{max}$ ) is usually undesirable because designers typically wish to maximize the absorbed energy while minimizing the loads transmitted to the surrounding vehicle structures.

The introduction of buckle initiators is often the most practical method to reduce  $P_{max}$ . Buckle initiators are intentional "imperfections" which can take many forms and shapes, such as initial folds, indentations, localized thin areas, darts, etc. The exact positioning and the fine-tuning of the "strength" of these imperfections are most easily determined through quasi-static crush testing. However, it should normally be attempted to induce an initial fold that is similar to the fold that the section would naturally form without buckle initiator, while avoiding stress concentrations severe enough to initiate cracking

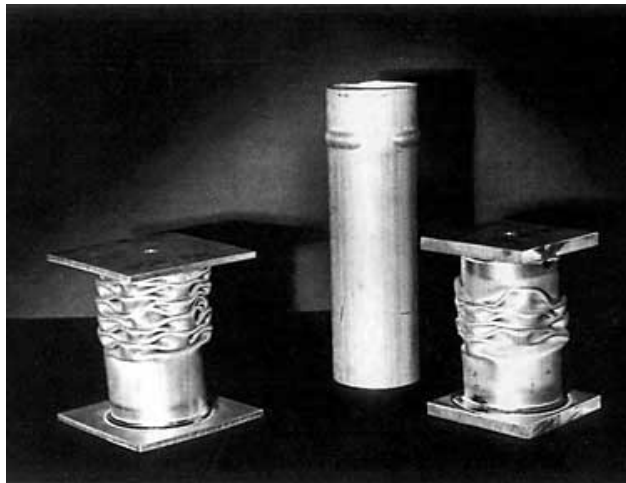

Effect of a buckle initiator in a circular crash box

Correctly designed buckle initiators can reduce  $P_{max}$  to the same level as the secondary load level and even lower, if necessary.

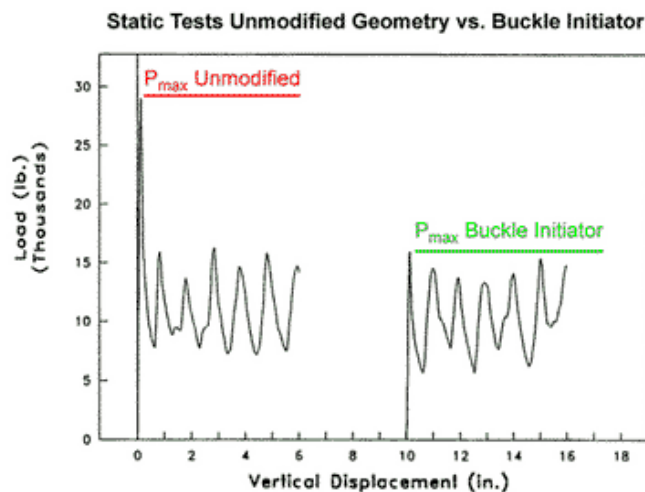

Load-deflection curve without (left) and with (right) buckle initiator

### 3.2.5 Crash simulation with FEM

Up until the mid-1980s, crash management structures were developed primarily by experimental methods and many time-consuming, cost-intensive tests were necessary. At that time, computers were not powerful enough and the simulation software used in industrial applications was not suitable in terms of effectiveness, user-friendliness and reliability for the simulation of crash situations. In the design and sizing of components with respect to crash considerations, recourse had to be taken to traditional engineering methods.

Over the last years, computer-aided engineering (CAE) has become the established key method for vehicle development. Structural design has been significantly affected by the appearance of CAD (computer-aided design) programs, while structural analysis procedures were improved by the development of simulation programs based upon the finite element method (FEM). The parallel development of ever more powerful computers and better simulation programs has led to a situation in which a complete body structure can now be designed and sized on a computer, also in terms of its crashworthiness. Whereas in the past large numbers of prototypes were used in crash tests, i.e. a very expensive and time-consuming procedure, just a few tests are needed today to validate the simulation results.

.All the crash simulation programs available on the market are based on the finite element method (FEM). In this method, complex structures are partitioned into a large number of small sections of elementary geometry known as finite elements. Parts of sheet metal or other thin-walled, two-dimensional components are divided into triangular or square-shaped elements, while cubic or tetrahedron elements are used for solid components. In contrast to the complex overall structure, the finite elements are accessible for calculation purposes. The behaviour of the overall structure is then calculated by suitably linking the individual elements within the program.

As far as simulation problems are concerned, dynamic and quasi-static problems must be generally distinguished. For crash problems, the initiation of the folding and crumpling of the vehicle structure is controlled by dynamic processes. The explicit finite element programs used to simulate these processes boast very simple software architecture and high computing speed even when dealing with large scale dynamic problem scenarios. A further significant advantage is the high level of program stability. Thus, a large number of crash scenarios can quickly be virtually tested at reasonable expense.

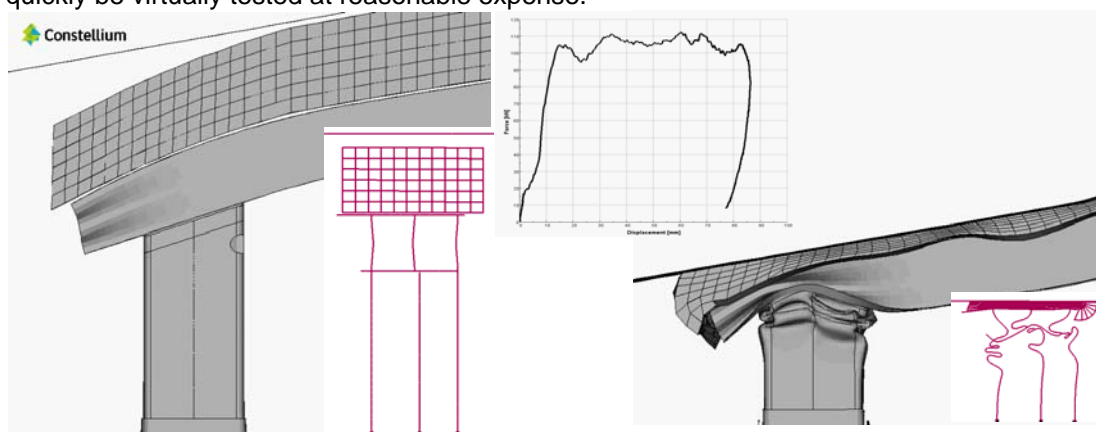

**Numerical simulation of the crash performance of a front bumper (AZT test)**

**Source: Constellium**

Today, extremely reliable simulation results can be achieved for a very broad spectrum of applications in the field of vehicle crash testing using FE programs, both in qualitative and quantitative terms. However, when it comes to correctly predicting the behaviour of exotic materials such as foams, honeycomb materials or fibre reinforced composites the limits of FE programs are reached. Nor is it possible to quantitatively predict material failure and crack formation in cast components, fibre reinforced composites as well as joining elements such as riveted joints, weld points, weld seams or bonded joints. The aforementioned inadequacies of crash simulation programs are currently still research topics.

### 3.2.6 Failure criteria

#### Aluminium failure model – Introduction

In order to successfully implement aluminium components and structures in crash critical applications, efficient analytical tools are necessary to understand and predict the behaviour of structures in various loading and deformation modes. Hence, the development of a material failure model for crashworthiness design is required.

The first task is to develop the capability to predict the formation of cracks in aluminium components under dynamic impact. With this capability, the design can be modified already at an early stage to prevent or limit the formation of cracks, enabling the design to pass the mandatory qualification tests with a minimum amount of testing. The second task is to link the structural crashworthiness to the microstructure of the aluminium alloys and manufacturing processes, but this is beyond the scope of this chapter.

There are different material failure models currently under consideration. The specific aluminium failure model discussed here has been incorporated into the non-linear explicit finite element code LS-DYNA. The new executable is used to predict crack initiation and propagation in aluminium structures under static and dynamic loading. It has been successfully used in several automotive design projects to pass government mandated and customer required crash tests.

In the following sections, the basis of the material fracture properties needed for the failure model, a general description of the failure model, and the simulation and verification test results are discussed. The major benefits of this tool include:

- Improved alloy development and selection
- Reduced number of tests and
- Decreased design time and cost.

These benefits lead to an optimized design for cost, weight and crash energy management; therefore, facilitating the implementation of aluminium components and structures into automotive applications.

#### Aluminium failure model – Definition of critical fracture strain (CFS)

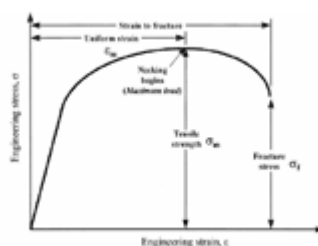

Typical engineering stress-strain curve

In order to use the failure model and to run the modified LS-DYNA code, the fracture properties of aluminium alloys need to be determined first. For this failure model, only the standard tensile test needs to be performed. Using the typical engineering stress-strain output, the critical fracture strain (CFS) can be determined (equations (1) and (2)).

## THE Aluminium Automotive MANUAL

$$CFS = -\ln(1 - \varepsilon_{t,eng}) \quad (1)$$

in which  $\varepsilon_{t,eng}$  represents the engineering thinning strain and consists of two parts, uniform and localized necking strains.

$$\varepsilon_{t,eng} = \frac{\varepsilon_m}{2} + \left(1 - \frac{\varepsilon_m}{2}\right) \times \left(1 - \frac{\sigma_f}{\sigma_m}\right) \quad (2)$$

where

$\varepsilon_m$  - Engineering strain at the maximum load  
 $\sigma_m$  - Engineering stress at the maximum load  
 $\sigma_f$  - Engineering stress at the fracture load

Several engineering assumptions are made in the development of the CFS:

- Strains in the thickness and width directions are the same before the maximum load,  $P_{max}$ .
- The true stress after  $P_{max}$  is a constant.
- The width strain is constant after  $P_{max}$ .

The first assumption is already used in LS-DYNA. By using the second and third assumption, the total thinning strain at fracture is determined.

In general, materials with higher CFS values will perform better under large deformation. However, apart from the CFS value, there are also other material properties that need to be considered as well. For example, in order to absorb the highest crash energy possible, the alloys with a higher yield strength should be chosen. Note that the required CFS value is dependent on the specific geometry and structural performance requirements.

### Aluminium failure model – Failure model development

Similar to the forming limit diagram (FLD), a fracture strain diagram (FSD) can be drawn in the principal strain space. The FSD curve represents the strain in the material at fracture and lies at the major strains greater than the FLD due to the additional non-uniform plastic strain associated with localised necking. There are a variety of possible empirical failure criteria that may be used to determine the FSD. An experimental study has been performed to determine the FLD and FSD for a variety of aluminium alloys. The results indicate that the operative failure criterion appears to be one of constant thickness strain.

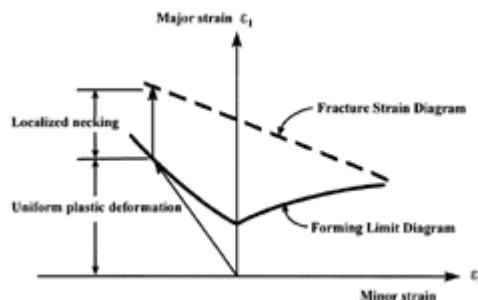

### Position of forming limit and fracture strain diagrams in principal strain space

This criterion was also used to simulate strain localisation and fracture between holes in an aluminium sheet under uniaxial tension. Therefore, the constant thickness strain criterion was chosen and used in this failure model.

In the earlier stages of the failure model development, the first approach involved applying the FSD to each integration point of the shell element. The element was removed only when thickness strains at all integration points reached the FSD. Less cracking was observed in the computer simulation than in actual tests. The second approach removed the element when



## THE Aluminium Automotive MANUAL

thickness strain at any integration point of an element reached the FSD. With this approach, it was found that the surface cracks observed in the tests were predicted as through-thickness cracks and the predicted load carry capability was lower than the force measured in the tests.

In the current failure model, the constant thickness criterion is only applied to the integration points in the tension side of an element. In addition, a compressive failure criterion is proposed and applied to the integration points in the compressive side of the element. For convenience the effective / equivalent plastic strain is used in the compressive failure criterion, since the effective plastic strain is already calculated in LS-DYNA. When the effective plastic strain at an integration point reaches the critical effective plastic strain, the integration point fails in compression. This criterion is applied to the compression side of the elements after the element has already failed at least at one integration point in the tension side.

### Aluminium failure model – Verification of model

In order to demonstrate the accuracy of the failure model, verification studies included the simulations of coupons and components under free bending, three-point bending, axial crush of extrusions and crush tests of hat-shaped castings.

In the simulation, contact is controlled by the automatic single surface contact algorithm. Coulomb friction theory is used during the contact and the coefficient of friction is assumed to be 0.5.

Thickness change for shell elements having elastic-plastic material properties is included in the analysis. Moreover, the true stress-strain curve up to the maximum load is used and five integration points are assigned to shell elements.

#### a) Aluminium cast products:

Two simulations were conducted for quasi-static free bending and lateral crush tests. The material used was a hat-shaped CZ29-T6 casting with a CFS of 11%. (CZ29 is an internal to Alcoa alloy designation).

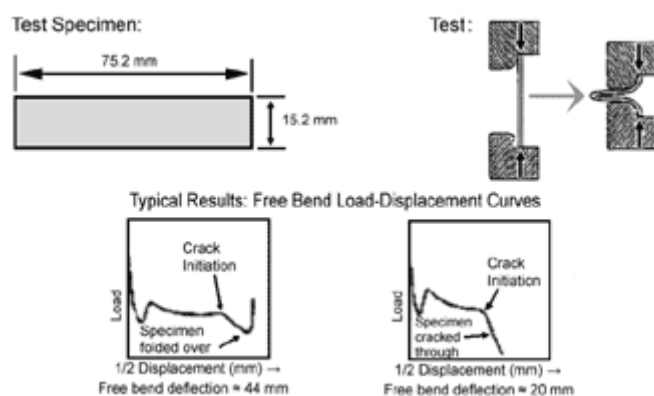

### Free bend test configuration

The testing of castings in quasi-static free bending was simulated by finite element analysis using the modified code. For comparison, the resulting load-deflection data obtained from LS-DYNA without the failure model are given. It can be seen that the test results show some variation, but the simulation results of the modified code are very close to the lower bound of the test results.

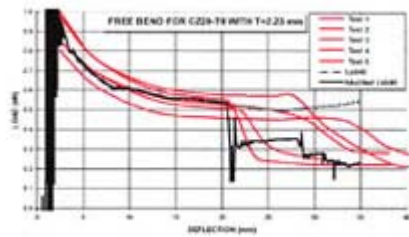

**Load-deflection curve for free bend of CZ29-T6 casting (2.23 mm)**

In addition, four hat shaped castings made from CZ29-T6 were subjected to a quasi-static lateral crush test. A solid steel cylindrical indenter was used to induce bending deformation into the castings. The test configuration is shown below. The locations of cracks observed on the tested casting are shown next.



**Configuration of crush test of CZ29-T6 hat-shaped casting**

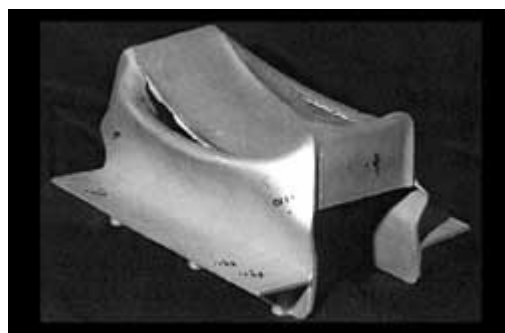

**Quasi-static test results for crush of CZ29-T6 hat-shaped casting**

The crush test was simulated using modified LS-DYNA code. Since the wall thickness of the casting was not symmetric, the entire casting was considered in the simulation. The indenter was modelled by rigid elements with a constant velocity toward the casting and the bottom of the casting was fixed.

The final deformed shape obtained from the modified LS-DYNA run is shown below. It can be seen that predicted crack locations are found at the same locations as the actual cracks in the tested casting. Note that a surface crack predicted in the simulation is actually a through-thickness crack in the tested specimen. The force versus displacement results from the analysis and the tests show that the simulation with the standard LS-DYNA code over-

## THE Aluminium Automotive MANUAL

predicts the force recorded from the test while the modified code results very closely correlate to the test data.

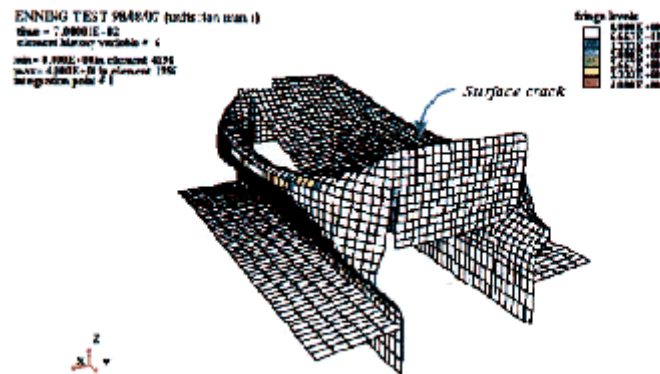

Quasi-static simulation results for crush of CZ29-T6 hat-shaped casting

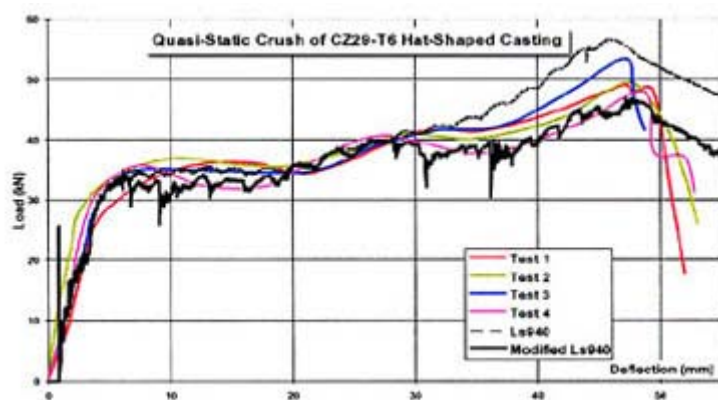

Load-deflection curve for crush of CZ29-T6 hat-shaped casting

### b) Aluminium extrusion products:

Two simulations were conducted for quasi-static axial crush and three-point bend tests of aluminium extrusions. In the quasi-static axial crush test, the extrusion material used in the tests was EN AW-6063T6 produced with two different cooling rates resulting from fan and water quenches. The true stress-strain curves for these two different cooling rates are very similar, but the CFS values are quite different. The CFS values for fan cooled and water quenched materials are 17% and 25%, respectively.



Quasi-static axial crush test results for a fan cooled 6063-T6 extrusion

## THE Aluminium Automotive MANUAL

The typical final deformed shape of a fan cooled extrusion (shown above) indicates the presence of cracks which are typically found at two different locations in the test specimens. The first location is at the inside corner of the extrusion and the second location is at the outside corner of the folded area. The deformed shape obtained from the simulation with LS-DYNA shows the predicted cracks at the same locations as the actual cracks in the tested specimen.

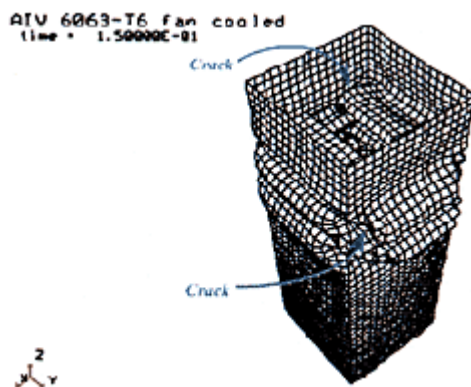

### Quasi-static simulation results for the axial crush of the fan cooled 6063-T6 extrusion

The typical final deformed shape of a water quenched extrusion is shown below. Some surface roughness (or orange peel) was observed, but no cracks appeared. The simulation with LS-DYNA predicts a few isolated through-thickness and surface cracks. The location of these cracks is consistent with the location of the surface roughness observed in the tested extrusion.



### Quasi-static axial crush test results for a 6063-T6 extrusion, water quenched

RIV 6063-T6 water quenched  
time = 1.50000E-01



**Simulation results for the axial crush of a water quenched 6063-T6 extrusion**

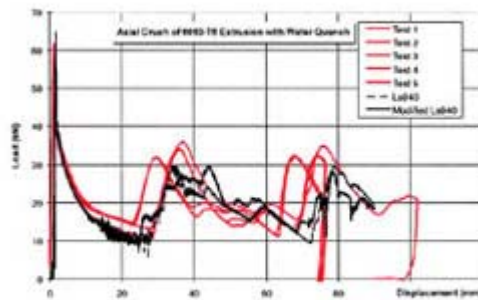

**Load-displacement curve for the axial crush of a water quenched 6063-T6 extrusion**

Quasi-static three-point bend tests were run using an EN AW-6013-T6 extrusion (CFS=11%) between roller supports. Each test specimen was loaded at its centre by a smooth roller (see figure below).

3-POINT BEND FOR AL6013-T6 BOLT-ON profile  
time = 1.0000E-01

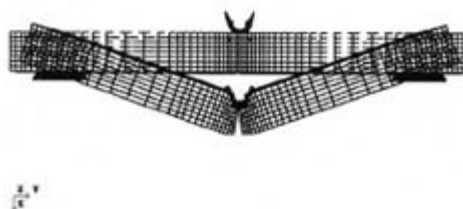

**Quasi-static simulation results for three point-bending of a 6013-T6 extrusion**

The simulation of the three-point bending test showed that a crack started at the tension side of the extrusion and then propagated through the whole section at the centre of the extrusion. The sudden drop in the load displacement curve is caused by crack growth (see below). It can be seen that the crash energy absorption capability is significantly reduced after crack propagation begins.

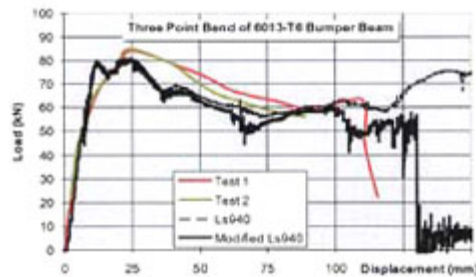

Load-displacement curve for three-point bending of a 6013-T6 extrusion

The extrusion process enables an easy integration of internal features (e.g. internal walls) into closed box sections. Such internal diaphragms can be very effective to increase the axial collapse resistance of impact members and/or sill sections. The following example compares a single cell rectangular impact member with a double cell version during the initial stages of axial collapse: Both sections are triggered by geometrical features in order to initiate collapse from the impacted end of the beams. In this case, a constant impact velocity (15.6ms<sup>-1</sup>) has been applied in order to enable a direct comparison of the results.

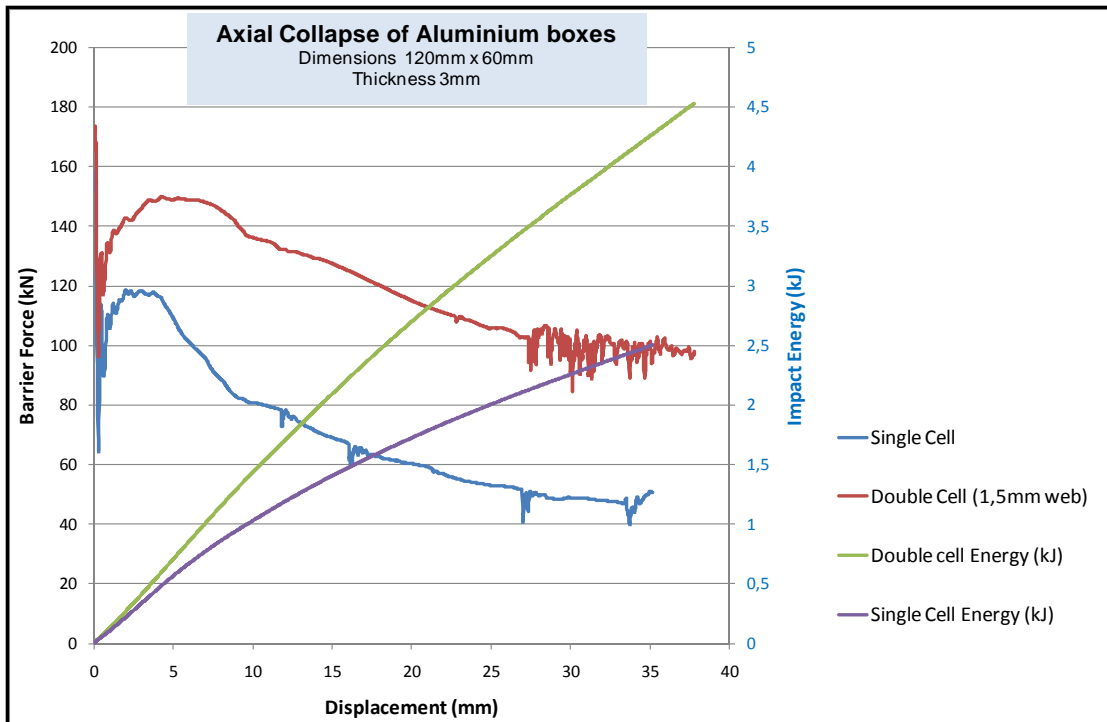

The buckling force needed to collapse these sections is a function of the thickness and a characteristic length, in this case the length of the longest walls. The internal diaphragm changes the characteristic length and the forces the transition to a higher energy buckling mode.

### 3.2.7 Pedestrian safety

As soon as motorized vehicles appeared, pedestrian safety became a concern for public authorities and car producers. This contributed in late 20th century to the development of more rounded shapes design in car bodies, especially at the front of the vehicle where pedestrian impact is the most likely to occur.



**A more rounded (“softer”) car front improves pedestrian protection**

**Source: Opel**

Of main interest in this context is the design of car hoods that can dampen the head impact of a pedestrian in case of collision. Compared to steel bonnets, aluminium bonnets show:

- a significantly (- 40%) lower head impact criterion (HIC) value;
- a significantly (- 25%) lower acceleration peak;
- local plastic deformation over a larger bonnet area; and a
- 15-20% larger deformation depth of the bonnet,

combined with weight savings of up to 45%. Most serious head injuries occur when there is insufficient clearance between the hood and the stiff underlying engine components. In this case, the (relatively) soft first impact will be followed by a harder second impact on the underlying engine components. The calculation of the HIC value leads then to an overall higher HIC value (+ 22%).

In case of the bonnet, pedestrian protection can be improved (i.e. the HIC value can be reduced) by a suitable material selection for the outer and inner panel, but in particular through an appropriate design of the inner bonnet. In order to benefit most from the characteristics of aluminium bonnets, a cone design of the inner bonnet should be applied. With the optimized design, the full pedestrian safety potential of an aluminium-based solutions can be implemented for many cars.

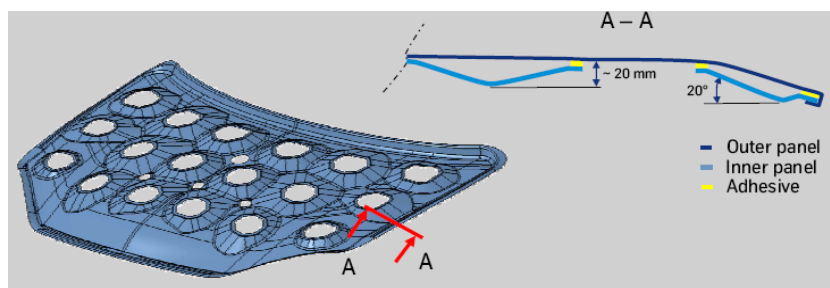

### Bonnet inner panel design optimized for head impact protection

Recent accentuations of the pedestrian protection regulations may require even more drastic measures for safe car hood design:

- providing of sufficient deformation space;
- implementation measures for improved and better controlled energy absorption; and
- removal or proper shielding of vehicle structural elements and other rigid components (e.g. hinges).

As a consequence, a higher bonnet line will be often needed to accommodate sufficient energy absorbing air-space in the engine compartment above the power unit. A gap of approximately 10 cm is usually enough to allow the pedestrian's head to have a controlled deceleration. However, creating room under the hood is not always easy because there are usually other design constraints, such as aerodynamics and styling. In some regions of the hood, such measures can even be impossible, i.e. along the edges on which the hood is mounted and along the cowl where the hood meets the windshield. More ambitious solutions have attempted to overcome this problem by developing systems including airbags that are activated during the crash and cover the stiff regions of the hood. When the pedestrian is detected by sensors, the bonnet hinges are released and the airbag starts to inflate. Consequently, the bonnet is lifted and the airbag covers the windscreen and A pillars.

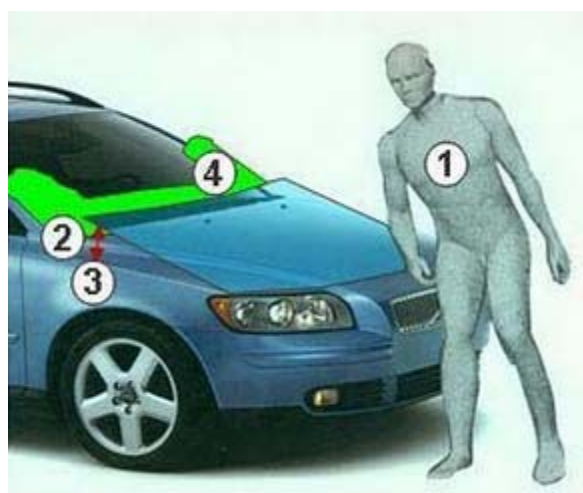

### Head impact protection using airbags cover the critical stiff area system

Another possibility is the use of active bonnets which pop up in a pedestrian impact to provide sufficient crush space above the engine. Pop-up of the bonnet can be initiated different methods, e.g. by pyrotechnic devices (in the Jaguar XK and the Citroën C6) or by a system of springs (Mercedes E class). In this case, the lower weight of the aluminium bonnets offers significant advantages when designing appropriate deployment mechanisms.



**The pop-up bonnet of the Jaguar XK adds 6.5 cm extra clearance over the engine block**

**Source: Jaguar**

Another critical issue is the protection of the limbs. Most limb injuries occur due to a direct blow from the bumper and the leading edge of the hood. Thus, attempts at reducing these



## THE Aluminium Automotive MANUAL

injuries involve reducing the peak contact forces by making the bumper softer and increasing the contact area and by limiting the amount of knee bending by modifying the geometry of the front end of the car. Computer simulations and experiments showed that when cars have lower bumpers, the thigh and leg rotate together causing the knee to bend less and thus reducing the likelihood of injuries. Deeper bumper profiles and structures under the bumper (such as the air dam) can also assist in limiting the rotation of the leg.

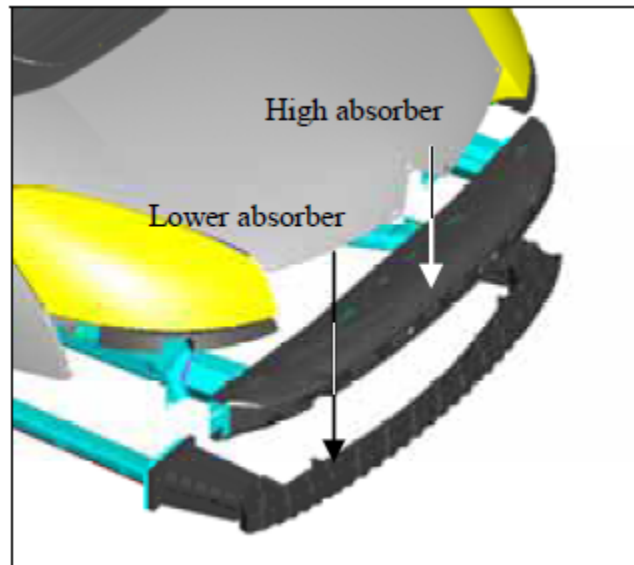

**Citroën C4 Picasso – Position of the two absorbers designed to protect the leg of a pedestrian**

### 3.3 Fatigue

#### 3.3.1 Introduction

Fatigue is the process by which materials fail after cyclic loading. Fatigue limit, endurance limit, and fatigue strength are expressions used to describe this material property, i.e. the amplitude (or range) of cyclic stress that can be applied to the material without causing fatigue failure. Whereas ferrous alloys have a distinct fatigue limit, i.e. an amplitude below which failure will not occur due to cyclic loading, aluminium alloys do not have such a distinct limit. They will eventually fail even from small stress amplitudes. In these cases, a specific number of cycles (usually  $10^7$ ) is chosen to represent the fatigue life of the material. In this case, the term “endurance limit” is used.

The fatigue life of a material consists of two periods:

- crack initiation and
- crack growth.

Fatigue measurements focus either on the measurement of the total fatigue life (crack initiation plus crack growth) or on the measurement of the crack growth rate starting from a known defect size. There are several different tests used to measure fatigue performance of aluminium alloys. These range from uniaxial tests on simple specimens to tests on full scale components after manufacture. Fatigue tests can also be performed for a range of loading conditions.

The traditional method for determining fatigue life involves measuring the total life for crack initiation and growth. Since the time for crack initiation is very sensitive to the surface finish of the material, it is critical that this is carefully controlled. Tests are performed across a range of stress amplitudes and plot of stress amplitude (S) against cycles to failure (N) is produced, commonly known as an S-N curve.

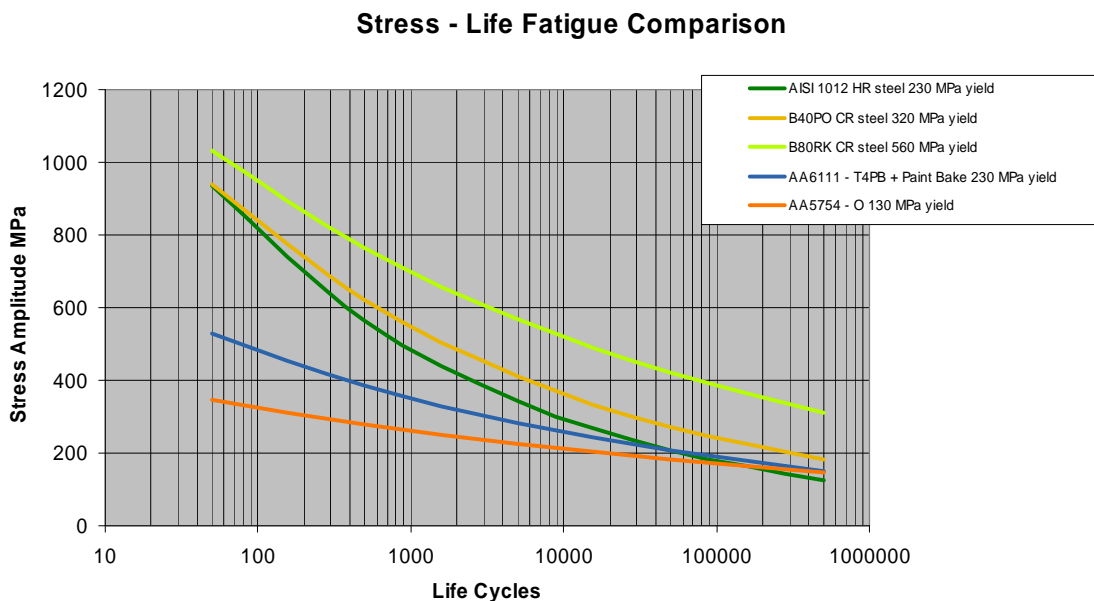

**Stress-life comparison of the aluminium alloys AA6111 and AA5754 as well as selected steel grades. Source: Novelis**

## THE Aluminium Automotive MANUAL

However, the fatigue properties of the pure aluminium alloy are seldom the relevant design parameter. The fatigue performance must be considered in terms of an aluminium product (product form, alloy, temper and geometrical parameters), a manufactured component and eventually an assembled module. In particular for aluminium castings, the fatigue characteristics will depend strongly on the local solidification conditions. Even more important are generally the effects of specific design characteristics (e.g. sharp corners), the manufacturing parameters (joint type and joining procedures, post treatment, residual stresses) with their inherent variations and the environmental parameters (load and stress type, frequency, corrosion, temperature).

In many cases a properly planned experimental program with subsequent statistical analysis of the results may be required in order to be able to distinguish the relevant differences in fatigue behavior. Guidance is provided in many textbooks and there is also ample literature on this topic in many national standards, especially in the recommendations of the American Society for Testing and Materials.

General information on fatigue testing machines is found in the textbooks; further information may be obtained directly from the manufacturers of test machines. More difficult are general statements describing the preparation, set-up, and testing of full-size structural components. These components will usually be actual parts of the structure itself, although often typical test specimens e.g. open (U-, T- or H-shaped) beams or hollow shaped (box, double web) beams are used. The applied test configuration will be either pure bending (so called four-point bending) or a combination of bending, shear and axial loading. Information may be obtained here from the respective reports of various laboratories which are performing such tests. As an example, there is a report on the extensive aluminium beam test program which was carried out in the eighties at the Technical University of Munich (contributing among other results to the collection of background data for Eurocode 9).

Fatigue testing is a most important part of the design and production development of any structural aluminium component. Experience shows that service failures of structural aluminium components due to fatigue are relatively common. Compared to structural steel components, corrosion is much less of a problem for aluminium components. The figure below shows the result of an investigation of service failures in aluminium products for ground vehicles.

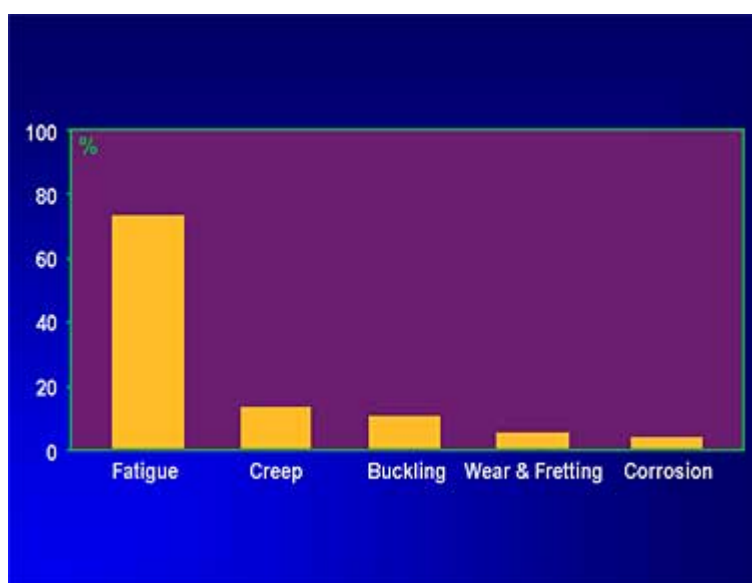

**Investigation of service failures in aluminium products**

**Source: Alcoa**

Aluminium fatigue data are often compared to those for mild or low alloyed steels and found to be distinctly lower (relative to the static strength). It should be remembered, however, that

## THE Aluminium Automotive MANUAL

due to stiffness design criteria, the overall stresses in aluminium components are often also significantly lower and therefore compensate for the lower fatigue resistance. Nevertheless, design and fabrication must avoid generating stress concentrations, especially in welded constructions.

Given a similar load spectrum, aluminium components for similar function have to be assessed differently from the conventional steel components with respect to their fatigue performance:

- The design loads can often be reduced since lightweight components are replacing heavier parts.
- Typical design features of aluminium structures (e.g. larger cross sections) will improve fatigue resistance.
- The integration of additional function into aluminium products like extrusions and castings can reduce the number of joints and thus improve fatigue behaviour.
- For the production of aluminium assemblies, various types of joining technologies are usually available, i.e. it is possible to select the joining method which offers optimum fatigue performance.
- In specific cases, it is possible to enhance the fatigue strength of a joint by the application of combined joining techniques (e.g. adhesive bonding combined with spot welding or self piercing riveting).

Special attention must be given to the evaluation of the fatigue performance of aluminium castings. The lower mechanical properties and reliability of the aluminium cast alloys compared to wrought alloys is caused by the presence of casting defects and other microstructural inhomogeneities, which will also act as preferential fatigue initiation sites. Furthermore, there is a lack of complete understanding of the fatigue behaviour of aluminium cast alloys and of the respective relationships to microstructural features. In general, cast pores are preferential crack initiation sites in cast materials. But secondary dendrite arm spacing, inclusions and grain size are also considered to be important microstructural factors to understand the fatigue behavior of cast components.

### 3.3.2 Design Philosophies

There are five major design philosophies for the design of components and structures with respect to fatigue resistance:

#### 1. Infinite life:

If all stresses are below the endurance limit of the material and/or component, failure should never occur. This criterion is an appropriate method for the design of structures subjected to high numbers of life cycles such as some rotating parts. Sometimes it is also used for safety-critical parts.

#### 2. Safe life:

In safe-life design, the allowable fatigue stress or strain is related to that which would be expected to cause failure at the required lifetime. This approach is widely used throughout the automotive industry.

#### 3. Fail safe:

For safety critical applications, a more conservative approach to fatigue analysis is required. The fail-safe design philosophy has been developed in the aircraft industry. It assumes that the structure's construction is such that limited cracking or even failure of a given component would not produce a complete or catastrophic failure of the structure.

#### 4. Damage tolerant:

The aircraft industry has taken the fail-safe concept even further by assuming that crack-initiation time is zero. In other words, it is assumed that **all materials contain inherent flaws** and/or manufacturing flaw exists at a critical section. The principle is shown schematically in the figure below. The initial flaw size is the longest length that cannot be reliably detected by their inspection method.

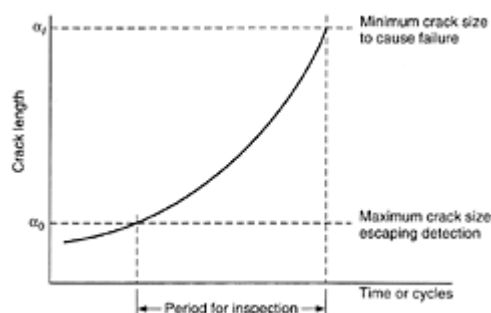

**Damage-tolerant approach to design**

The useful fatigue life is then defined as the number of cycles required to propagate pre-existing flaws to a critical size. The critical size is often related to the critical size for unstable crack propagation. In order to use this approach, it is necessary to determine the crack growth rate. The defect tolerant approach to fatigue uses concepts from fracture mechanics and a pre-notched specimen is typically used for testing.

#### 5. Good practice:

This approach utilizes details which have historically been shown to be fatigue-resistant. An important aspect of a good practice is the minimization of stress concentrations.

### 3.3.3 Product development methodology

The figure below gives an example of a product development process.



**Product Development Methodology**

**Source: Alcoa**

Design for fatigue performance starts early in the development phase. The first step is the implementation of a good practice design. This is followed by a conceptual phase and a detail design phase. The following pages give a more detailed description of the elements of this methodology.

#### **Conceptual design phase:**

As a simplified guideline, the following steps should be taken in the conceptual design phase of a component or structural module:

- Simplify the load history
- Calculate the nominal stress using the static material strength
- Reduce the loading stress by optimizing layout/sections/thickness
- Place joints in low stressed areas
- Select the alloy temper and joining method which balances best manufacturability, cost and performance
- Consider safety factors, potential corrosion effects and preliminary product specifications
- Determine allowable stress/strain level for required life.

It should be noted that the influence of the alloy and the temper on the fatigue life of assembled aluminium structures becomes smaller with higher cycle numbers. An example for MIG welded butt joints is shown below.

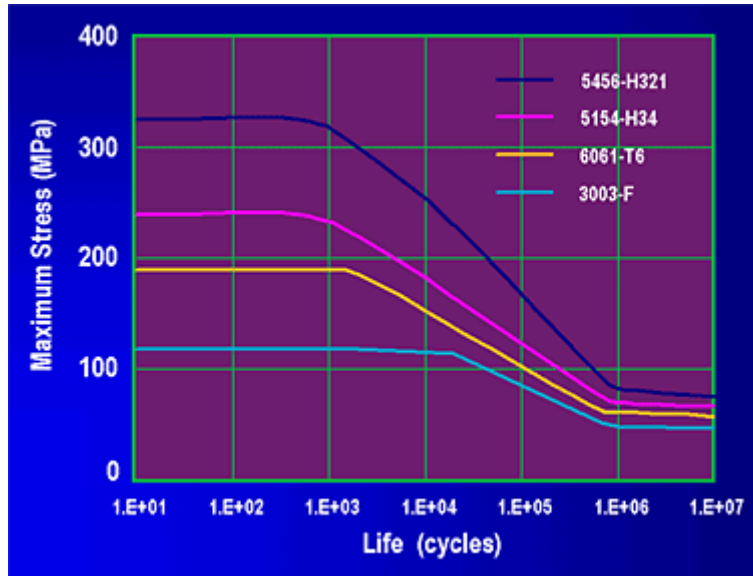

Effect of Alloy on fatigue performance of MIG Welded Butt Joints

Source: Alcoa

### Detailed design phase

In the detailed design phase, FE models are used. When using simplified FE models, the following steps are taken:

- Evaluate the fatigue performance of a component / structural module based on local stresses /stress ranges and mean stresses
- Apply appropriate design data and correction factors
- Iterate on design details
- Identify critical areas that require more refined modelling, i.e. the consideration of design details per production specification.

An example of a simplified geometry for FE analysis is shown below.

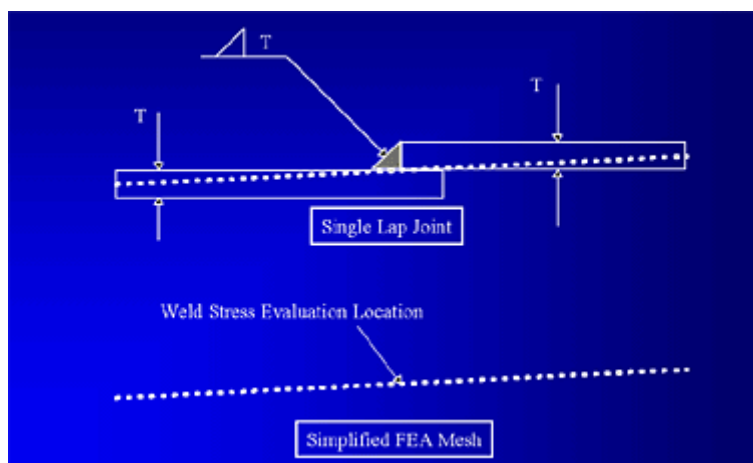

Simplified Mesh using shell elements and different material properties

Source: Alcoa

Using detailed FE models and simplified tests, the following steps are taken:

- Evaluate based on local elastic / plastic strains

## THE Aluminium Automotive MANUAL

- Perform simplified fatigue tests for correlation to the FE analysis
- Refine FE models and design data based on the correlation to the test results
- Refine design details
- Validation test results with the finalized structure.

The more detailed FEA model of the same lap joint is shown below.

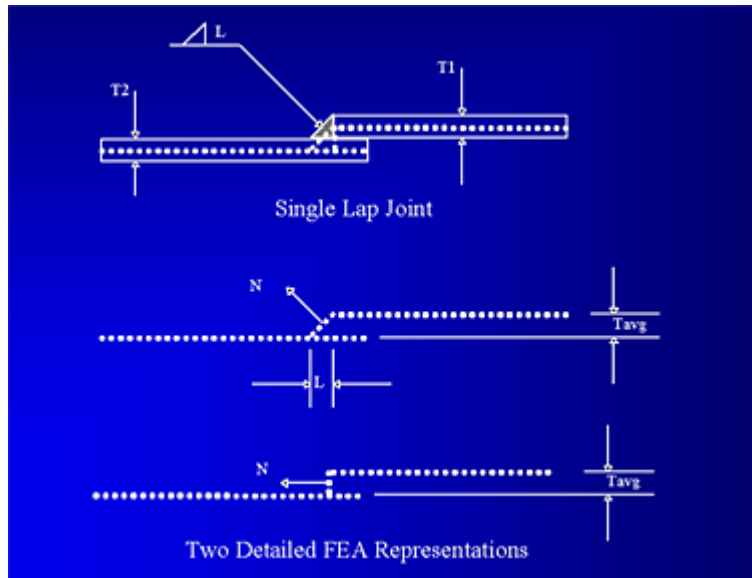

**Detailed FEA model (two representations)**

**Source: Alcoa**

Some fatigue design recommendations to facilitate the selection of specific design details with superior fatigue performance are presented below. For applicable fatigue stress calculation methods, see literature.

### **Good practice design:**

Some general design guidelines generated from experiences are given below:

- Components with smooth surfaces:
  - Avoid embossed trademarks that scores surface
  - Expect to have scratches, damages etc., i.e. design for a lower allowable stress to accommodate negative effects on fatigue strength

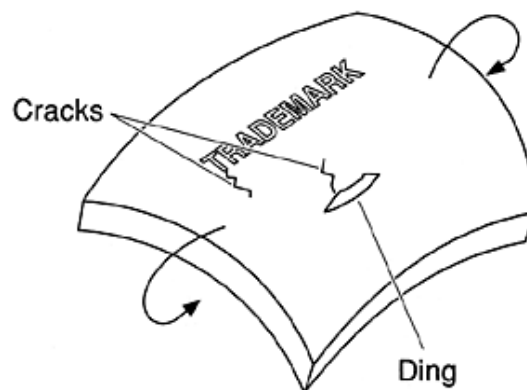

**Components with smooth surfaces**



## THE Aluminium Automotive MANUAL

- Beams bearing on top of flanges of other beams:

A beam bearing on the edge of a flange causes high local bending stresses at the fillet and thus causes a reduced fatigue performance.

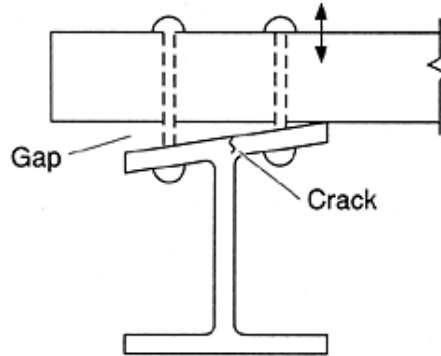

### Beam bearing on top flanges of other beams

A countermeasure would be to pull the beams together with strong fasteners or - better – to use shims so that load is transmitting through the web avoiding bending stresses.

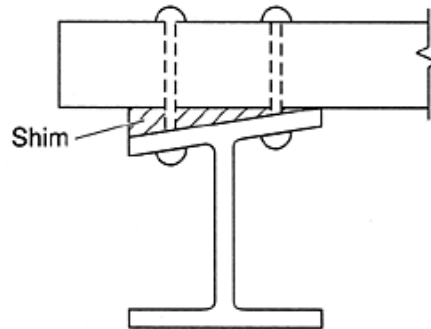

### Use Shims

- Welds on beams framing into web:

High local stress due to a short distance to the flange leads to the formation of a crack.

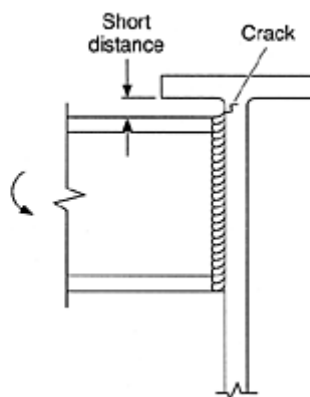

### Beam framing into web

A possibility is to enlarge the distance so that the web can deflect with a lower local stress.

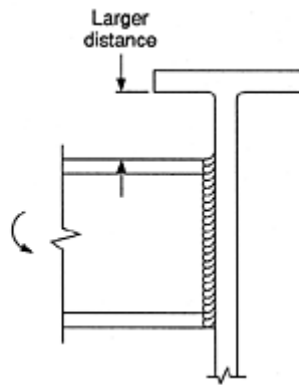

**Enlarge distance**

- Weld sizes:

Small welds on large, lightly loaded components (a) have low resistance to fatigue. It is better to employ welds that develop a significant portion of the strength of the parts to improve toughness and fatigue. Full penetration of the weld would be best.

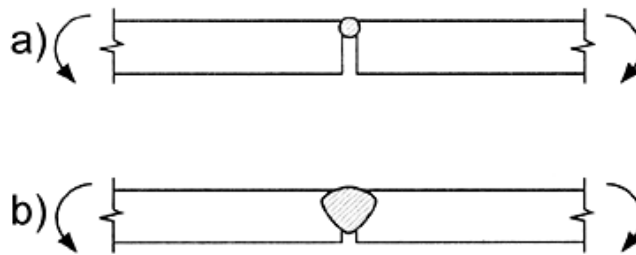

**Weld sizes**

- Termination of stiffeners:

High local stresses occur at the tip of a stiffener ending in the middle of a plate when the stiffener bends.

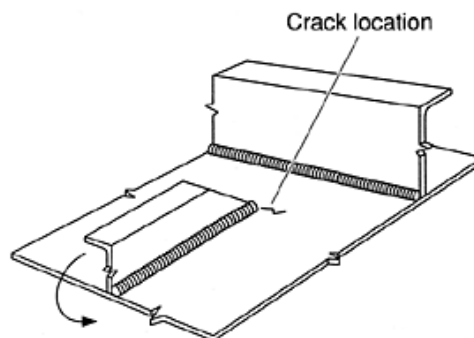

**Termination of stiffeners**

A better termination of the stiffener is the introduction of a frame stiffener to the other member to eliminate high local stresses.

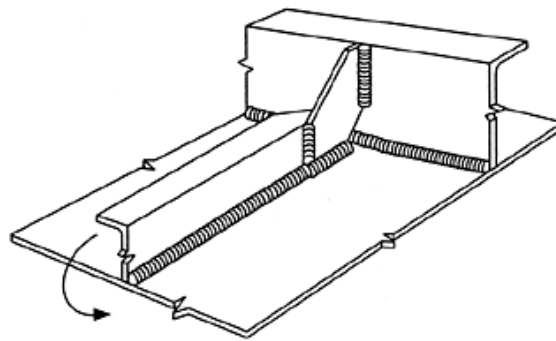

**Better termination of stiffeners**

- Beams changing direction:

A change in the beam direction causes transverse bending stresses in the flanges at the noted location:

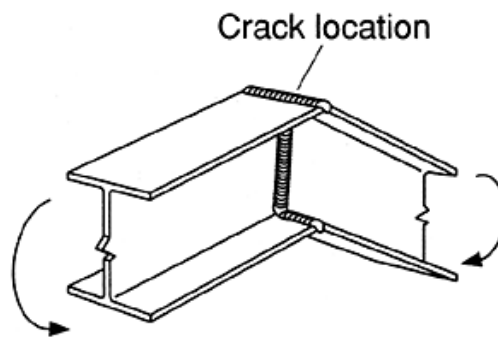

**Beams changing direction**

The use of a diaphragm at the point of change in the beam direction can prevent the transverse bending.

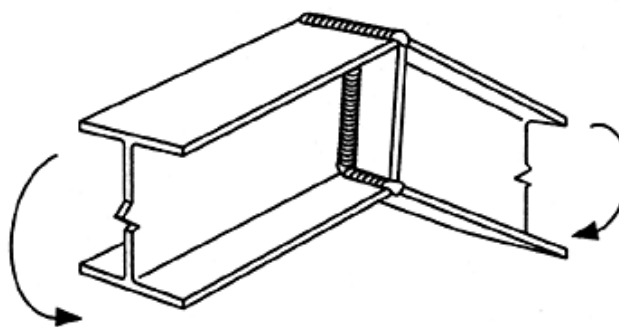

**Use a diaphragm**

- Misalignment of stiffeners:

The misalignment of stiffeners stopped and welded at each side of a diaphragm causes high local stress.

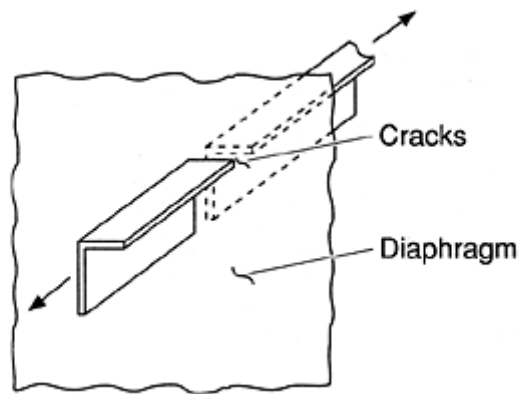

**Misalignment of Stiffeners**

A solution is to pass the stiffeners through the diaphragm and to close the opening with plates to eliminate misalignment and to reduce local stress.

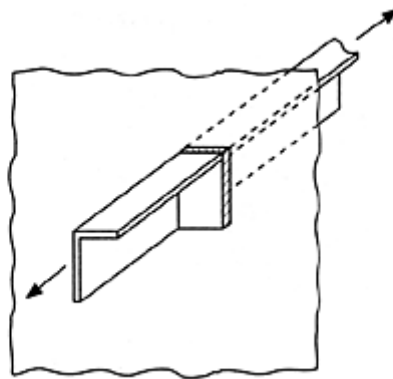

**Pass stiffeners through**

## 3.4 Corrosion

### 3.4.1 Introduction

An outstanding feature of aluminium and its alloys is the good chemical stability. The excellent corrosion resistance is due to a thin, tight and well adhering surface layer of aluminium oxide which forms spontaneously in air and is highly stable in the pH range 4.5 to 8.5. Outside of this pH-range, i.e. in strong acids or alkalis, the oxide film dissolves and the metal can suffer uniform corrosion. Within this pH range, i.e. in pH neutral aqueous solutions, the oxide film is stable. However, it can be locally dissolved in the presence of certain anions (for example Cl<sup>-</sup>) or cations (for example Cu<sup>2+</sup>) and a corrosion attack can occur. Depending on the alloy composition, also selective corrosion (i.e. intergranular and exfoliation corrosion) can occur on a bare aluminium surface.

The nature, extent and progression of the corrosion attack are determined on the one hand by the environmental conditions and the design features of the specific body component, on the other hand by the chemical composition, the microstructure as well as the surface properties of the material. Alloying elements (and to a small extent also defects of the crystal lattice) give rise to local changes of the electro-chemical potential of the aluminium matrix. Important factors are the type, size and distribution of the intermetallic particles as well as the local concentration of the alloying elements present in solid solution.

Aluminium components and assembled structures generally show a very high resistance to corrosive environments when properly designed and manufactured using appropriately selected alloys. The goal of this section is to provide an overview of the principle forms of corrosion that can occur on automotive aluminium components and to offer some general guidelines on how best to avoid these situations. A short description of the most important types of corrosion which can occur under unfavourable environmental conditions is given below. For a more detailed presentation of the mechanisms of aluminium corrosion, reference is made to other sections of this manual and to specific textbooks.

However, it must be kept in mind that the corrosion behaviour of a component or module is not only a material property, but depends on the total corrosion system. The corrosion system includes the material, the surface conditions, the electrolyte (corrosiveness of the medium), the environmental conditions (temperature, duration of impact of electrolyte, degree of movement and agitation), the presence of contaminations (dirt, salt), etc.

Furthermore, aluminium components in automotive applications are often painted or covered with corrosion protective coatings. In these cases, the corrosion system is completely different since the surface coating plays a major role and material corrosion is only relevant where the surface protection is insufficient or has been damaged. Thus, an evaluation of the complete surface coating system (including any surface pretreatment by the material/component supplier as well as the performance of the complete OEM cleaning, zinc phosphating and multi-layer paint system) must be taken into consideration.

Most important are also the influence of design and manufacturing. Even in aluminium intensive car designs, there are normally assemblies consisting of different materials. When different materials, but also different aluminium alloys are in electro-conductive contact, galvanic corrosion may occur. Another detrimental effect can be the appearance of crevice corrosion. Crevice corrosion can develop whenever moisture enters the crevice area between two adjoining surfaces, especially if salts are also present. Galvanic corrosion and crevice corrosion should be absolutely avoided by design or other special measures as both mechanisms can drastically accelerate the local corrosion attack. Corrosion incidence can be usually avoided by observing some simple design rules, which are described below.

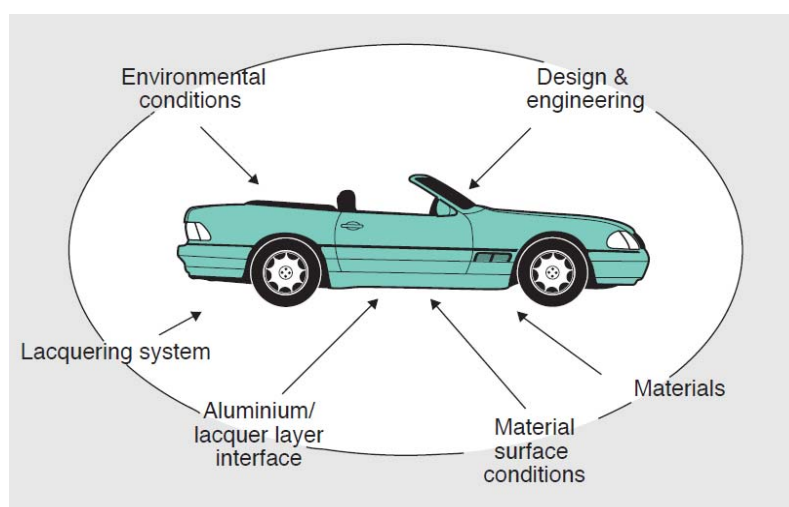

### Factors influencing the corrosion behavior of the lacquered car body

Source: Novelis

Another potentially very critical issue for structural components and modules can be the occurrence of corrosion fatigue. Corrosion fatigue can drastically reduce the lifetime of dynamically loaded aluminium structures. The best way to avoid corrosion fatigue is through proper fatigue-resistant design and – if necessary - the use of suitable protective coatings. Thus care must be taken to avoid surface irregularities, in particular sharp notches and fine surface cracks, which may act as nucleation sites for fatigue cracks. Furthermore, localized surface corrosion must be prevented since also such surface irregularities may initiate fatigue cracking.

In conclusion, it must be kept in mind that specific corrosion issues have to be examined on a case by case basis. There are many different factors which determine the corrosion mechanisms acting on any particular component or assembled module and thus also various methods that can be used to provide good corrosion protection. The guidelines offered in this section are therefore of general nature and great care to detail and field experience is necessary when applied to any specific problem.

### 3.4.2 Cosmetic corrosion

On a metallic bright, uncoated aluminium surface, the visual appearance can be deteriorated by pitting corrosion. Pitting corrosion is only seldom related to the microstructure of the material, but generally develops as a result of local effects of aggressive aqueous solutions (containing for example chloride or heavy metals) on the bare metal. Pitting corrosion is characterised by the formation of round dimples of different size. The resulting material loss due to corrosion is small; the strength characteristics of the sheet metal are not significantly impaired.



**Local pitting corrosion on an uncoated aluminium sheet**

**Source: Novelis**

In practice, the term cosmetic corrosion generally refers to paint performance of class “A” outer body panels. In order to fully understand and evaluate the reasons related to cosmetic corrosion issues, the performance of the complete lacquering line at the automobile producer (cleaning, zinc-phosphating (or alternative chemical pretreatment) and multi-layer paint system) must be taken into consideration. The main factors which influence the corrosion performance of painted automotive sheet are:

- Environmental conditions: presence of corrosive agents (e.g. salt load), temperature, humidity
- Properties of the lacquer: diffusion characteristics for H<sub>2</sub>O, O<sub>2</sub>, chlorides, etc., presence of active corrosion protection pigments in the lacquer
- Interlayer between the aluminium alloy and the lacquer
  - properties of the Zn-phosphate layer
  - surface condition of the formed panels before Zn-phosphating and lacquering (e.g. grinding has a negative effect on corrosion performance)
- Design/manufacturing effects: presence of crevices, formation of galvanic elements.

The sheet alloy composition and microstructure are factors of second priority. However, a complete review of all these factors is well beyond the scope of this chapter. From general experience, it can be stated that, provided all the necessary precautions are taken, the service performance of painted aluminium closures is excellent.

With respect to the painting of individual components, surface preparation prior to paint application is absolutely critical in order to achieve optimum corrosion performance. This is particularly the case for components such as cast aluminium wheels.

Experience clearly shows that a high level of resistance to cosmetic corrosion can be achieved using either low or high level fluoride phosphating or a dedicated aluminium finishing process. The advantage of the low fluoride process is that it allows both aluminium

## THE Aluminium Automotive MANUAL

and steel intensive vehicles to be treated on the same finishing line without the need to restrict the aluminium throughput. Furthermore, the formation of a uniform layer of zinc phosphate crystals on the aluminium sheet surface is not necessarily required to provide proper resistance to cosmetic corrosion. The most important treatment step seems to be the passivation treatment which follows the Zn-phosphating step. The passivation of the surface using a fluorozirconic acid treatment results in a thin uniform zirconium oxide layer that adheres well both to the aluminium substrate and to the electro-coated lacquer. The passivation treatment performs very similarly to the pretreatment layer developed in dedicated aluminium surface pretreatment processes. This is not unexpected since both treatments are based on similar fluoroacid systems.

Surface grinding during sheet surface rectification is the most important factor in promoting susceptibility to cosmetic corrosion developing during corrosion testing of vehicles and in service. The increased corrosion susceptibility following surface grinding is a direct consequence of the generation of ultra-fine grained, heavily deformed layers in the outermost surface. These surface layers are electrochemically more active than the underlying bulk material and are therefore preferentially dissolved during corrosion attack. More work is however, required to develop a mechanistic understanding of the activation of mechanically ground surfaces and the effect of paint bake treatment in increasing corrosion susceptibility.

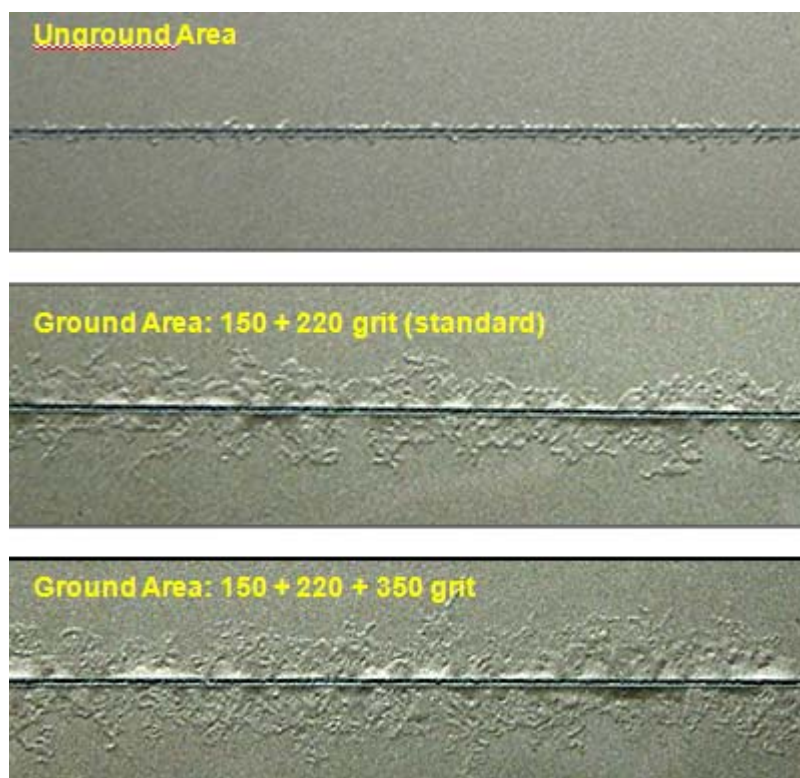

### Effect of surface grinding on the corrosion performance after conversion treatment and lacquering

Source: Novelis

It should be noted that for cosmetic corrosion to occur on a vehicle in the service phase, the paint system must be damaged to expose the bare metal. This is most likely where there is the risk of severe stone chip damage or scratches from minor collisions. However, it is therefore good practice to avoid the rectification of formed sheet parts or to minimize the effect of the grinding action by the application of appropriate grinding procedures and, if necessary, to add additional local protection.



### 3.4.3 Intergranular corrosion

Intergranular corrosion is characterised by a dissolution of the metal which proceeds preferentially along the grain boundaries. The cause for the occurrence of intergranular corrosion effects are differences of the electro-chemical potential between the grain boundaries and the interior of the grains, for example when the segregation of alloying elements leads to a distinct enrichment or deletion in grain boundary regions and/or if the grain boundaries are closely covered with precipitated particles. Whether intergranular corrosion has a detrimental effect on the material properties or not depends on the penetration depth. In case of a larger penetration of the corrosion attack, a deterioration of the mechanical characteristics can occur.

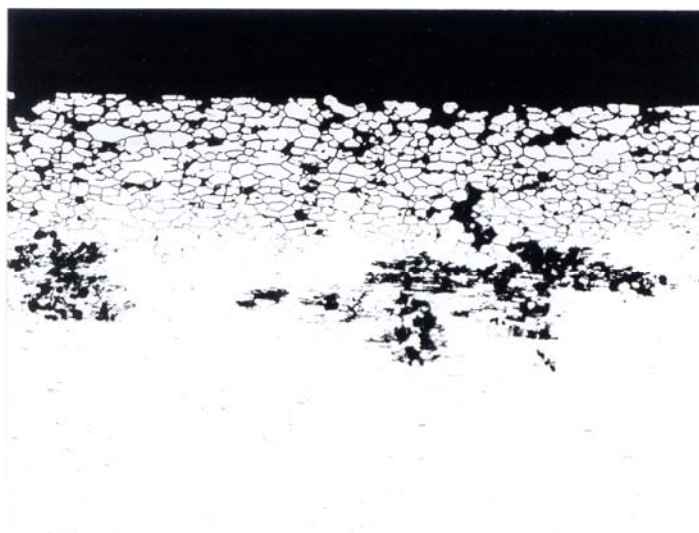

**Intergranular corrosion an aluminium alloy**

**Source: Novelis**

The effective intergranular corrosion mechanisms in two important automotive aluminium alloy classes are described below:

#### **a) Corrosion of AlMgSi(Cu) alloys:**

If bare AlMgSi sheet is exposed to aggressive corrosive conditions in laboratory tests, intergranular corrosion can occur under specific conditions. The corrosion resistance of the alloy sheet is mainly determined by the copper content, the silicon to magnesium ratio (or the excess silicon content) and the processing conditions. The negative effect of a copper content above 0.3 to 0.5% on the corrosion resistance of AlMgSi alloys (AA6xxx) is due to the formation of Cu-containing precipitates along the grain boundaries which lead - when the material is exposed to aggressive environmental conditions - to the preferential dissolution of the adjacent aluminium matrix. If the silicon to magnesium ratio exceeds 2.5, also precipitation of silicon particles can occur at the grain boundaries. Under aggressive environmental conditions, this effect can cause intergranular corrosion as well. On the other hand, the  $Mg_2Si$  phase which is always present in AlMgSi alloys shows a neutral behaviour. The high corrosion resistance of the AlMgSi car body sheet alloys typically applied in Europe is ensured by a closely controlled copper content and a silicon to magnesium ratio outside of the critical range.

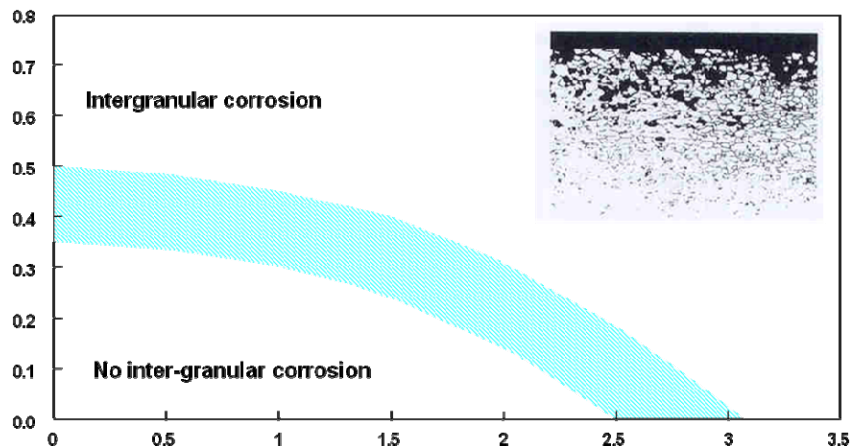

**Influence of the silicon-to-magnesium ratio and the copper content on the sensitivity of AlMgSi alloys to intergranular corrosion**

Source: Novelis

**b) Corrosion of AlMg(Cu) alloys:**

AlMg alloys (AA5xxx) with less than 3% magnesium are not susceptible to intergranular corrosion under normal service conditions. In alloys with a higher magnesium content, however, a continuous film of Mg-containing intermetallic particles can form at the grain boundaries during extended exposure to elevated temperatures (exposure time of 100 up to more than 1000 hours; temperature range of 65 to 150°C). In a corrosive environment, a selective grain boundary attack is then possible. It is important to always take into account the possible occurrence of this type of corrosion when AlMg alloy components are exposed to both a corrosive environments and increased temperatures. Such conditions can be expected for example for components which are located near the engine, the catalyst or the brakes. However, no intergranular corrosion occurs in AlMg alloys with > 3% Mg as soon as individual, not connected particles are formed at the grain boundaries. This is the case if the material is annealed at temperatures above 150°C. The result of such a stabilisation treatment is a material resistant to intergranular corrosion as long as it is not subjected to subsequent cold forming operations. The addition of copper has generally a negative effect on the corrosion resistance of AlMg alloys.

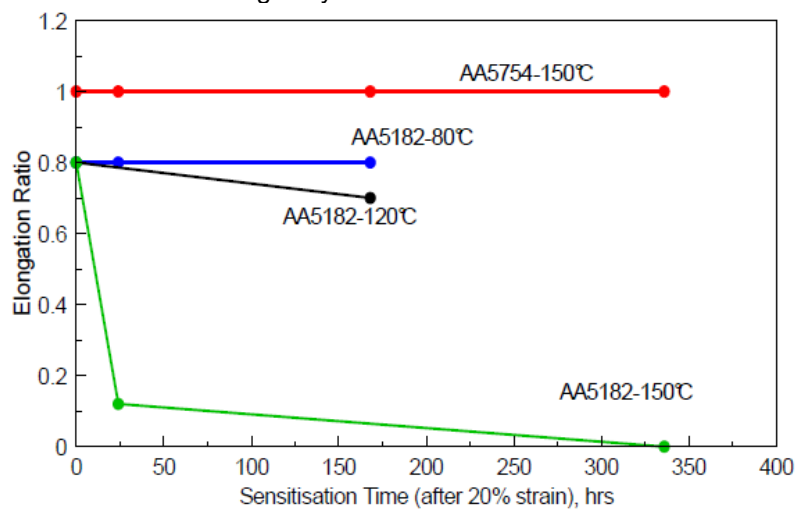

**Sensitivity of “O” temper AlMg alloys to intergranular corrosion (slow strain rate test data using a NaCl/H<sub>2</sub>O<sub>2</sub> solution – reference AA5754)**

Source: Novelis

### 4.4.4 Stress corrosion cracking

When intergranular corrosion attack has started on the surface, the penetration rate of the attack into the material can be increased by the presence of tensile stresses (tensile loads and/or residual stresses). Thus special care must be taken to avoid or minimize internal (residual) stresses, e.g. from forming or assembly operations. Furthermore, for components which are subjected to external tensile stresses and/or dynamically loaded parts, it is essential to have a microstructure which is not susceptible to intergranular corrosion.

The precondition for the occurrence of stress corrosion cracking is a combination of a corrosive environment, external or internal stresses in the elastic range as well as a microstructure allowing easy crack propagation. The initial electro-chemical corrosion attack is usually characterised by intergranular corrosion. Crack formation under mechanical loads initiates a further corrosion attack resulting in crack growth into the depth of the material. The crack propagation continues essentially perpendicular to the direction of the applied stresses.

AA 5XXX series alloys and certain AlMg casting alloys, commonly used for structural components, with magnesium content above about 3% can be susceptible to stress corrosion cracking after extended exposure to elevated temperatures. Some AA2XXX, 7XXX and 6XXX with high copper additions are also susceptible to stress corrosion cracking, but these are generally not used in automotive applications. For this reason, it is strongly recommended to use only AlMg alloys with a maximum content of 3% magnesium for structural components in automotive applications where exposure for long periods to temperatures in excess of about 75°C may occur.

When the use of AlMg alloys with higher Mg content is desired, consultation with the material producer is recommended and their applicability must be evaluated in detail. The thermal exposure of the part during its lifetime should be known and preferably a realistic, full component test should be performed. These guidelines are generally followed and there are no known records of field failures of structural components made from AlMg alloys due to stress corrosion cracking.

### 3.4.4 Crevice corrosion

Crevice corrosion on aluminium components can occur whenever moisture enters the crevice area between two adjoining surfaces, in particular if also salts are present. Often, the two adjoining surfaces would be aluminium, but one of the surfaces can also be of another material. It should be noted that once the corrosion starts, corrosion attack can also propagate intergranularly into the aluminium component. Crevice corrosion is most critical for situations where the crevice is formed by two conducting materials with different electrochemical potentials leading to an additional galvanic effect.



Crevice corrosion under a floor cover

Source: Novelis

An example of crevice corrosion underneath a carpet which covered the aluminium sheet is shown above. Moisture and salts had penetrated into the crevice between the carpet and the aluminium surface. In order to rectify this situation, a sealant was applied over the entire area between the carpet and the aluminium sheet, forming a barrier to the penetration of moisture and salts. This example illustrates how the use of sealants can be very effective in eliminating crevice corrosion issues.

#### Avoiding Entrapment Areas

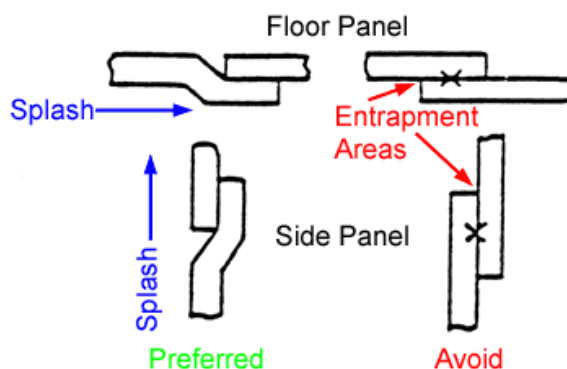

Orientation of floor panel and side panel lap joints is important in avoiding entrapment areas

Source: Alcoa

## THE Aluminium Automotive MANUAL

In addition to the use of sealants, proper design of joints effectively eliminates the potential of crevice corrosion. In essence, components should be constructed in such a manner that entrapment areas for moisture, salts and dirt are avoided as much as possible (see above). Ideally joints should be designed to allow good drainage and prevent the build up of poultrices which can trap salts and moisture.

In addition, consideration should be given to allow the access of paint or other corrosion protective coatings into crevice areas. This is particularly important whenever electro-coating techniques are applied. If a joint area is very tight, the paint cannot penetrate into the crevice. However, a small gap between adjoining surfaces is often sufficient to allow access, thereby providing a barrier to corrosion activity.

Whenever a sealant is used in any of these applications, it is important to ensure the sealant remains pliable. Sealants which dry out and crack will allow the access of moisture into crevice areas and can even accelerate the rate of crevice corrosion

Another form of crevice corrosion that should be mentioned originates from the use of certain foam materials occasionally used for sound dampening purposes. Some of these foams can retain moisture and salts and may lead to corrosion if there is no barrier material between the foam and the aluminium component. It is best to avoid the use of such materials and select a product that does not retain moisture.

In summary, guidelines for the prevention of crevice corrosion effects include:

1. Design of the component to allow good drainage and prevention of moisture, salt and dirt retention in crevice areas is critical.
2. Wherever possible, sufficient gaps should be left between components on a vehicle body to allow the ingress of electro-coat primer into crevice areas.
3. The use of paint and sealers between adjoining surfaces can be very helpful in preventing most crevice corrosion issues.

### 3.4.5 Galvanic corrosion

Special care must be taken when other materials are in an electro-conductive contact with aluminium, but also when different aluminium alloys are in contact with each other. In this case, the potentially resulting corrosion effects are determined by the actual difference of the electro-chemical corrosion potential. In most automotive applications, components consisting of different metals (most commonly steels and aluminium) have to be assembled. Since the environment of an automobile - especially in winter driving - must generally be regarded as aggressive, it must be anticipated that situations can occur where galvanic (or contact) corrosion in mixed metal structures develops.

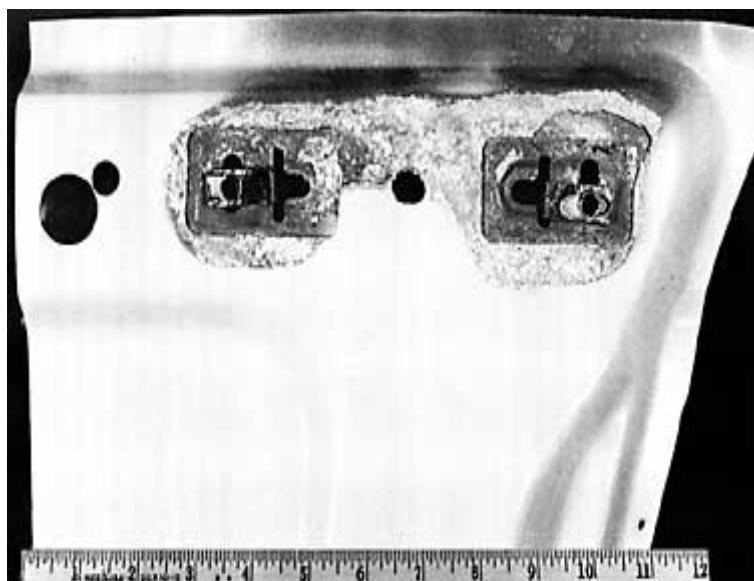

**Example of galvanic corrosion of 2xxx inner panel in contact with steel (the corroded area corresponds approximately the shape of the steel member that was in contact)**

**Courtesy: Alcoa**

Galvanic corrosion can occur whenever two dissimilar metals or - more generally - electrically conductive materials are in contact in the presence of an electrolyte. A common incidence of galvanic corrosion is caused by the use of steel fasteners in aluminium designs. Often, the aluminium component is being fastened to a steel component as well, which then forms another source of galvanic action. The primary prevention method involves the use of barrier materials to isolate steel from aluminium, thereby eliminating electrical contact.

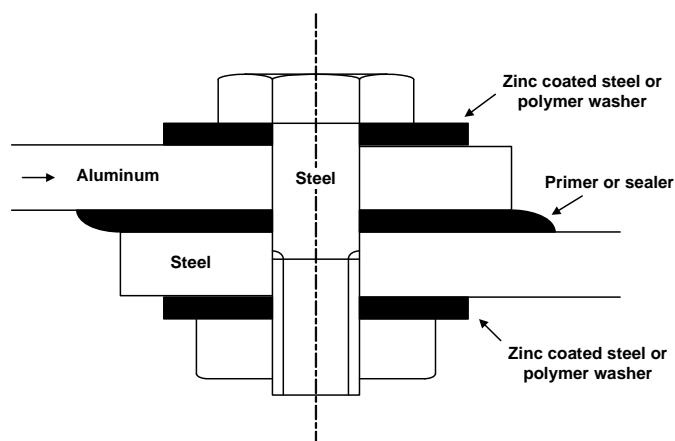

**Methods of sealing crevices between steel and aluminium surfaces**

The choice of the fastener protection material is critical. There are a number of sacrificial coatings which provide excellent protection against galvanic corrosion effects between aluminium and steel. Most important are zinc powder and/or aluminium flakes in an organic binder. It is also necessary to ensure that the coating is properly applied, otherwise much of the protection could be lost prior to or during the assembly. Other types of protective coatings on fasteners are also available, including aluminium and tin plated layers. Experience has shown that also properly galvanized steel fasteners are very effective in providing excellent galvanic corrosion prevention. Stainless steel fasteners can be used without any protective coating, but it should be noted that their use does not necessarily prevent the occurrence of galvanic corrosion. With the wide variety of available solutions, a detailed discussion with the fastener supplier is generally recommended to be sure the applied solution meets the requirements for a specific application.

The other alternative to consider is the use of a non-conductive barrier material between the steel and aluminium components. It is possible to use paint, a sealer or a polymeric material such as a polyester tape for this purpose. There is a wide choice of barrier materials and consideration must be given to cost and ease of manufacture as well as the required degree of corrosion prevention. In any case, the comment in the previous section concerning the requirement for a sealer to remain flexible and not to dry out or become brittle holds as well.

In any situation where moisture and salts can accumulate, additional sealant should be applied outside of the immediate joint area to isolate the seam as much as possible. It is also important to note that the barrier material should extend beyond the immediate contact area between the dissimilar metals. A distance of about 10 to 20 mm is usually adequate. If the barrier material covers only the adjoining surfaces, electrolyte can form a bridge between the two metals and corrosion can occur.

Pre-painting of the steel component prior to joining to the aluminium sections is often a very effective method of preventing galvanic corrosion. Again, consideration must be given to the overall requirements for manufacturing and cost.

Galvanic corrosion concerns are mostly associated with steel to aluminium contact. However, also other metals such as copper can result in galvanic corrosion with aluminium if the joints are not properly protected. But the measures described above also allow for excellent corrosion performance in service. On the other hand, there are alternative joining technologies to the use of fasteners which may be considered if concerns over galvanic corrosion remain, e.g. adhesive bonding. Care must be taken also in cases where the contacting material is not a metal. Examples are rubber or plastic materials containing carbon black which can act galvanic ally with respect to aluminium. The selection of the proper grade and level of carbon black must be considered to avoid any issues.

Although mixed material designs may result in galvanic corrosion of the aluminium partner, they have been successfully used in practice. Long term experience shows that it is possible to eliminate or minimize the effects of galvanic corrosion if appropriate precautions are taken. In summary, the following guidelines can help prevent galvanic corrosion issues:

1. The design guidelines mentioned above for the prevention of crevice corrosion should be strictly followed to avoid entrapment areas where moisture, salts and poultices can accumulate in or near a galvanic couple. In particular sufficient space should be left between steel and aluminium components to allow electro-coat paint to enter the crevice and form a barrier between the dissimilar metals.
2. It is essential to use properly protected fasteners. Primers, sealers and other barrier materials should be applied to fasteners and the adjoining surfaces of a galvanic couple. The barrier material should extend beyond the immediate contact area of the joint.
3. The use of pre-painted components prior to assembly should be considered where possible. If applicable, also the use of alternative joining methods such as adhesive bonding should be considered.

More specific recommendations:

### **Eliminate or reduce electrical contact**

The possible measures range from the use of sealants between dissimilar metal parts to the electrical isolation with insulating washers. In practice, sealants are generally used between body panels and non-conductive washers under fasteners.

### **Prevent contact with the corrosive environment**

Examples are the use of sealants and coatings with inhibiting compounds to prevent the entry of moisture to the dissimilar metal interface or simply painting the cathode (e.g. steel) adjacent to the aluminium part. The location, environment, expected service life and cost dictate the type of the applicable sealant or paint.

### **Limit time of exposure to corrosive environment**

This point is frequently most easily solved by effective design. Joints between dissimilar metals should be designed so that moisture cannot accumulate and soil and dirt are readily washed away. Examples are the elimination of crevices that can hold debris, exposed lap joints that face downward for ease of drainage and limiting dissimilar metal contact to vertical rather than horizontal surfaces.

### **Use components and/or fasteners with sacrificial or compatible metal coatings**

Zinc plate in the form of galvanized steel is a popular choice because zinc acts as a sacrificial anode, i.e., the zinc coating corrodes preferentially and protects the aluminium. Aluminized steel has also been used although it is a higher cost material than galvanized steel. Cadmium is very compatible with aluminium in most environments. For this reason, cadmium plated steel has been frequently the fastener of choice in the past when corrosion compatibility was needed. But this solution has been abandoned today.

### **Avoid gaskets and seals that can hold moisture**

Among the tapes and gaskets available, butyl and butyl-isobutylene provide excellent protection. EPDM rubber and neoprene are partially effective. Oleo resinous, asphalt impregnated felts and papers are the least effective.

In order to minimize corrosion attack in butt welds and lap joints, the weld material (or rivet or bolt) should be electro-chemically less active than the larger area metals being joined:

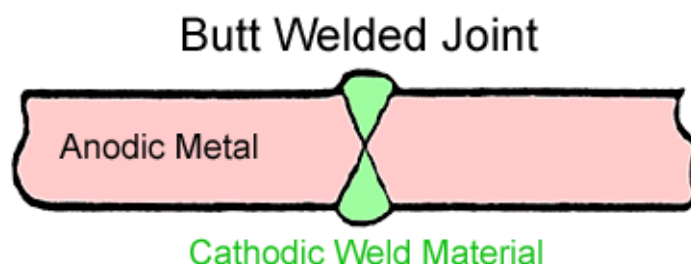

In lap joints, the use of fillet welds, insulating material or a seam sealer is recommended:



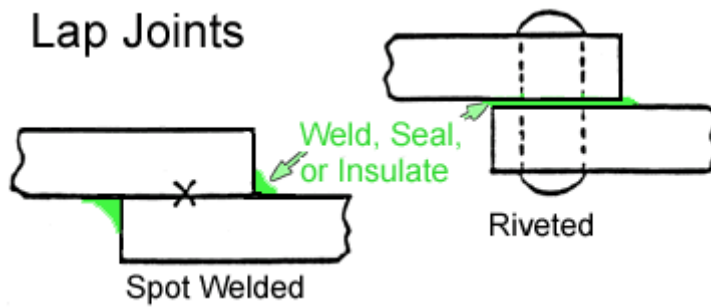

Entrapment sites in offset lap welds and standing seams should be eliminated with a sealer or a bead weld:

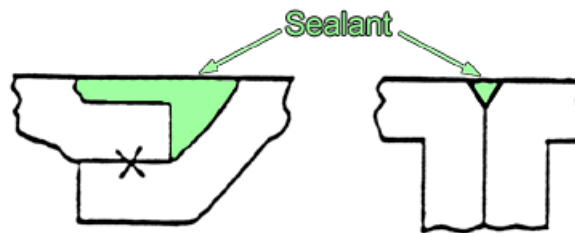

Metallic fasteners which join aluminium to a dissimilar metal should be made of a material which acts cathodic to aluminium. For example, steel bolts should be used in an aluminium-steel joint and not aluminium bolts; aluminized steel bolts are even better.

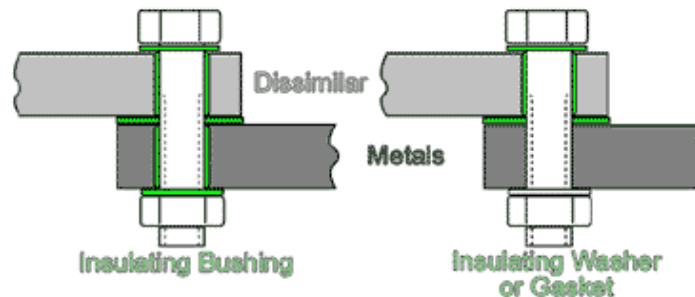

Coatings should be applied to both the anode and the cathode or to the cathode only, never to the anode only. Damage to coating on an anode would result in serious corrosion due to small anode/large cathode combination. Protection can be increased by coating the faying surfaces of the dissimilar metals as well. Sealants should be applied to crevices for best results.

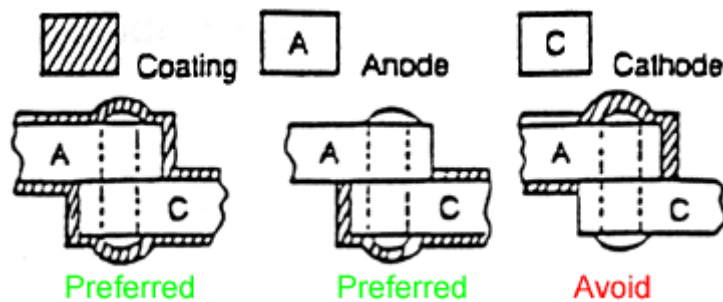

Joints exposed to direct splash should be protected by flanges. These may have to be angled to protect without creating entrapment sites:

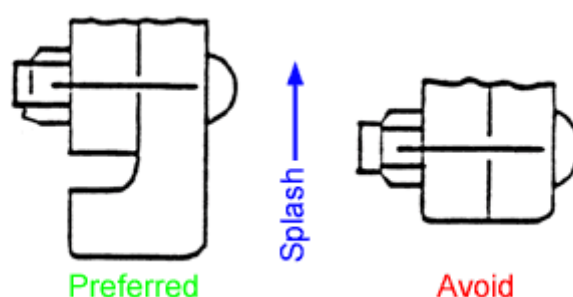

### 3.4.6 General guidelines on the corrosion behaviour of aluminium materials for applications in automotive structures

#### 5xxx alloys

The alloys of the 5xxx-series have a high resistance to corrosion, moderate to medium strength, excellent formability and good weldability.

**Pitting and Shallow Pit Corrosion:** All 5xxx-series alloys have a very good resistance against pitting and shallow pit corrosion in chloride containing and mostly pH neutral aqueous solutions.

**Intergranular Corrosion:** Alloys with magnesium content below 3 wt.% are not sensitive to intergranular corrosion. Alloys with magnesium content exceeding 3 wt.% can show a microstructure which may be sensitized to intergranular corrosion when exposed in service over extended time periods to temperatures between 60°C and 200°C. The time until sensitized microstructure appears depends on the magnesium content (the higher the earlier) and on the exposure temperature (worst temperature range between 110°C and 150°C). As an example, an alloy with 3.5% Mg might be able to withstand thermal loadings at 70°C for up to 10.000h without getting sensitized while the same alloy might develop a sensitized microstructure when exposed for more than 250h at 130°C. Suppliers can deliver products stabilized with special processes (e.g. temper H112) which increase time to sensitization, however, some subsequent manufacturing processes (e.g. severe cold-forming, welding) can decrease time to sensitization again.

Intergranular corrosion attack is most critical since corrosion induced cracking can occur under tensile stresses (external loads or internal residual stresses). When the use of AlMg alloys with higher than 3 wt. % Mg is desired for structural applications, consultation with the material producer is recommended and their applicability must be evaluated in detail. For safety critical parts, the thermal exposure of the part during its lifetime must be known and preferably a realistic, full component test should be performed.

#### 6xxx series materials

The alloys of the 6xxx-series show a good resistance to corrosion, especially to atmospheric corrosion, a high level of mechanical properties, a good formability and weldability.

**Pitting and shallow pit corrosion:** The alloys of the 6xxx-series show a corrosion resistance which is similar to that of the 5xxx-series alloys.

**Intergranular corrosion:** The so-called “Cu-free” 6xxx-series alloys with less than 0.3% Cu commonly used for automotive extrusions and sheets ranging from AA6060 to AA6082/AA6016 resist this type of corrosion. Care has to be taken only for materials with an extreme Si/Mg ratio ( $> 3$ ) as well as with higher Cu-containing alloys. Copper contents above 0.3% increase the strength of 6xxx series alloys, but may also affect their stability against intergranular corrosion. AA6061 automotive components containing 0.15 – 0.40 wt.% Cu proved to be fine, but the higher the Cu content, the more attention is needed to avoid this kind of corrosion. Components made out of Cu-containing 6xxx materials should be tested against intergranular corrosion or provided with a proper corrosion protection. This is for example the case for body-in-white applications where a suitable coating system (pre-treatment and lacquer) is used. The alloy AA6111 with nominally 0.7 wt.% Cu is extensively used for outer body panels with good long-term experience.

### 7xxx materials without copper

The copper-free alloys of the 7xxx-series have moderate to high strength (depending on alloy and age hardening temper), excellent toughness, good workability, formability and weldability. The corrosion resistance of these materials strongly depends on the temper and the manufacturing processes used to get the end product.

When in contact with other aluminium materials, the copper-free 7xxx-series alloys always behave anodic (due to the zinc atoms in solid solution), so they might act as a galvanic anode.

**Pitting and Shallow Pit Corrosion:** Due to the high zinc content mainly shallow pit corrosion will occur. The resistance against shallow pit corrosion is fair, but lower than that of 5xxx-series and 6xxx-series materials.

**Exfoliation Corrosion:** 7xxx material is susceptible to exfoliation corrosion in conditions with highly elongated grain structure. Solution heat treatment and aging result in a good resistance to exfoliation corrosion. On the other hand, welding may lead to an increased susceptibility to exfoliation corrosion in the heat-affected zone.

**Intergranular Corrosion and Stress Corrosion Cracking (SCC):** Depending on the applied temper, copper-free 7xxx alloys can show considerable susceptibility towards intergranular corrosion. Thus care must be taken to select the proper temper for any given application. Properly age hardened (T6) or overaged (T7) components show good resistance to intergranular corrosion.

The copper-free 7xxx-series alloys are less resistant to SCC than other types of aluminium materials under tensile stress conditions (tensile loads and/or residual stresses). The best resistance to SCC for these alloys is observed in artificially aged tempers (T6 and T7). Therefore applications of these alloys must be carefully engineered and close co-operation between design and engineering, manufacturing and material suppliers is strongly advised in all cases.

When cold forming and welding is required during manufacturing, a subsequent full heat treatment (solution heat treatment, quenching and aging) is recommended to avoid problems due to corrosion (exfoliation, intergranular and stress corrosion). Simple re-aging is possible, but does not provide optimum performance.

### 7xxx materials with copper

## THE Aluminium Automotive MANUAL

When in contact with other aluminium materials the copper-containing 7xxx-series alloys can behave either as cathode or stay neutral, depending on the temper (the determining factor is the copper in solid solution).

**Pitting and Shallow Pit Corrosion:** Due to the zinc and the copper content the resistance against pitting and shallow pit corrosion is rather poor compared to 5xxx- and 6xxx-series materials.

**Exfoliation Corrosion:** Solution heat treated material shows fair to good resistance, highest resistance is reached for over-aged (T7x) tempers.

**Intergranular Corrosion and Stress Corrosion Cracking (SCC):** Depending on the applied temper, 7xxx alloys can show considerable susceptibility towards intergranular corrosion. Thus care must be taken to select the proper temper for any given application.

An important aspect is also their susceptibility towards SCC. Most critical are stress loads in the non-working directions (ST for rolled material, LT for extrusions). The resistance to SCC of the higher copper-containing 7xxx-series alloys depends on the quenching rate and the temper. Over-aged tempers (T7x) show a good resistance to SCC, while it is not recommended to use materials in temper T6. When cold forming is required, a subsequent full thermal treatment (solution heat treatment, quenching and aging heat treatment) is recommended.

Thus further processing like forming or mechanical joining can have a significant influence on the corrosion behaviour of the product (materials of this alloy group are generally not fusion welded). Therefore applications of these alloys must be carefully engineered and consultation amongst designer, product producers and suppliers is advised in all cases.

### 2xxx series material

The 2xxx-series alloys, in which copper is the major alloying element, are less resistant to corrosion than alloys of other alloy series.

When in contact with other aluminium materials, the 2xxx-series alloys always behave as cathode (due to copper atoms in solid solution), so they might act as a galvanic cathode and increase the corrosion rate on the partner.

**Pitting and Shallow Pit Corrosion:** Due to the high copper content, mainly pitting corrosion will occur. The resistance against pitting is very poor (compared to 5xxx- and 6xxx-series materials) and is also influenced by the temper. T3 and T4 are better for thin material, while for thicker gauges over-aged tempers T6 and T8 can be advantageous.

**Exfoliation Corrosion:** Exfoliation corrosion may occur for non-recrystallized material without subsequent solution heat treatment and ageing.

**Intergranular Corrosion and Stress Corrosion Cracking (SCC):** Intergranular corrosion susceptibility can be avoided by proper quenching after solution heat treatment. For thicker sections, over-aging can be advantageous. 2xxx alloys generally show low SCC resistance, especially in ST-direction (rolled material), therefore tensile loads should be avoided.

Further processing like forming of the material can have a significant influence on the corrosion behaviour of the product (materials of this alloy group are generally not welded). Therefore applications of these alloys must be carefully engineered and consultation amongst designer, application engineers, product producers and suppliers is advised in all cases.

## Methods to increase the corrosion resistance of high-strength aluminium alloys

The most effective means for minimizing stress corrosion cracking (SCC) in high-strength aluminium alloys is the proper choice of alloy and temper. Products with recrystallized grain structure are generally more susceptible to SCC than materials with an unrecrystallized microstructure. In unrecrystallized materials, the most critical situation is the presence of tensile stresses in the short-transverse direction, the resistance in the other direction can be fairly good. Whether or not SCC develops in a susceptible aluminium alloy product depends on both the level and the duration of the applied stresses. So other important means for SCC control are minimizing stresses in the metal by designing the product below the minimum (threshold) stress that is required for cracks to develop. However, also the stresses which might already be present in the material (intrinsic stresses, thermal loads) have to be taken into account.

*Controlling sustained stresses:* SCC that occurs in service is in most instances the result of sustained residual or assembly stresses acting in an adverse direction. The potential presence of such residual stresses is not always obvious and therefore not considered by the designer. Five important steps can be taken to control sustained tension stresses:

- Select stress relieved products where possible
- Avoid residual tension stress introduced by plastic deformation of fully hardened materials
- Observe the proper sequence of machining operations and heat treatment to avoid sustained tension stress
- Guard against assembly stresses
- Protective coatings should only be used when the coating completely and permanently isolates the metal from the corrosive environment.

*Surface cladding:* To increase resistance against pitting and intergranular corrosion, high-strength aluminium materials, especially flat rolled products, are clad on one or both surfaces with a metallurgically bonded thin layer of pure aluminium or another aluminium alloy. The applied material combination must be properly selected. One possibility is to select a highly corrosion resistant aluminium alloy as the surface layer which prevents a corrosion attack on the core material (as long as the clad layer is not locally penetrated and the cut edges are properly protected). The other possibility is to choose the surface material in a way that the cladding is anodic to the core so that it also electrochemically protects the core at exposed edges and at abraded or corroded areas. For proper material selection and recommendations on subsequent manufacturing processes, consultation of the material supplier is strongly recommended.

Resistance against	5xxx-series		6xxx-series		7xxx-series				2xxx-series	
	Mg < 3wt. %	Mg > 3wt. %	without copper		without copper		with copper		natural aged (T3/T4)	artificial aged (T6/T7/T8)
			artificial aged (T6/T7)	with copper artificial aged (T6/T7)	natural aged (T3/T4)	artificial aged (T6/T7)	natural aged (T3/T4)	artificial aged (T6/T7)		
Pitting & Shallow Corrosion	excellent	excellent	very good	good	good	good	moderate	moderate	moderate	poor
Intergranular & Exfoliation Corrosion (base material)	excellent	depending from thermal loading	good	moderate	poor	good	poor	moderate	poor / moderate	moderate
Stress Corrosion Cracking (SCC)	not applicable	not applicable	not applicable	not applicable	poor	T6: moderate T7: good	poor	T6: poor T7: good	poor	moderate
Corrosion of welded joints (HAZ)	very good	depending from welding	good	depending from welding	poor	good	not applicable	not applicable	not applicable	not applicable
Corrosion of mechanical joints	very good	very good	very good	very good	moderate	good	poor	poor	poor	poor
Corrosion protection by cladding	not applicable	not applicable	not applicable	not applicable	not applicable	not applicable	improves pitting & shallow pit corrosion.		improves pitting & shallow pit corrosion.	

## Corrosion performance of aluminium materials for structural applications