

Design – Aluminium design for cost optimization

Table of Contents

4	Aluminium design for cost optimization.....	2
4.1	Introduction	2
4.2	The role of the envisaged production volume	5
4.3	Design economics	8
4.3.1	Life cycle cost.....	8
4.3.2	Relationship between weight and cost	9
4.4	Cost-efficient design solutions with aluminium.....	10
4.4.1	Introduction	10
4.4.2	Stamped sheet components.....	12
4.4.3	Components made from extruded sections.....	29
4.4.4	Cast solutions.....	42

4 Aluminium design for cost optimization

4.1 Introduction

The success of the various aluminium body design concepts depends in particular on the availability of the appropriate aluminium material quality. In this respect, intensive development efforts during the last years have led to significant product improvements allowing new innovative design solutions. A necessary pre-condition is the convergence of a number of factors of commercial, technical and metallurgical nature. A key requirement for a positive outcome of the project is also the close collaboration of the development engineers of the aluminium supplier with their partners within the automotive industry.

Apart from technical considerations, the design and manufacture of aluminium automotive structures requires today the observation of sustainability aspects, i.e. it is necessary to take into account:

- ways to minimize production waste and its deposition,
- recycling processes for the applied materials,
- health and safety aspects and
- life cycle assessment views, e.g. savings of fuel and emissions.

Most important, however, are the economical considerations. In this section, the design aspects influencing the economics of aluminium use in cars are treated in more details.

When simply compared on a mass basis (i.e. material price per kg), the price of aluminium is significantly higher than that of iron and steel. Even compared on a volume (or surface) basis, which is more meaningful for specific applications, there is still a clear price difference between the two materials. In addition, there may be some design- and/or process-related extra cost. An important issue can be the missing know how and experience in design and production for aluminium. Furthermore, within a traditional automobile manufacturing plant, the existing fabrication equipment will not be optimally suited for aluminium processing.

Detailed studies show that from a user point of view, additional cost for lightweighting are accepted by the customer – up to a certain amount. The acceptable cost limit for lightweighting measures depends on many factors ranging from external constraints (e.g. regulations regarding fuel consumption), the expectations of the customers regarding the performance of the considered car model to the specific application (i.e. any additional benefits achieved by the weight reduction). Therefore the development of automotive design and manufacturing concepts which are optimally adapted to aluminium – and thus also most cost-effective – is of highest priority.

An important lightweighting task is the search for the optimum design solution from a weight and cost perspective. A too heavy construction uses too much material and thus adds cost without providing additional benefits. Too heavy designs can be avoided by the application of proper design and engineering methods, supported by a reliable material model, a profound material database and the existence of appropriate design standards and/or guidelines, numerical simulation programs, etc. But there is also the danger to choose too extreme lightweighting measures by selecting highly sophisticated solutions asking for advanced materials and/or manufacturing technologies resulting in a loss of time and money (high material qualification cost, investments in new fabrication technologies, etc.). Therefore, it is essential to evaluate the cost-efficiency of any lightweighting measure at all times.

THE Aluminium Automotive MANUAL

In lightweighting with aluminium, significant cost reductions can be realized by the application-orientated selection of aluminium design principles and fabrication technologies. This approach led for example to the development of the AUDI spaceframe body concept for small to medium production volumes. The spaceframe concept exploits all possibilities offered by the aluminium extrusion and high pressure die casting technology with respect to parts and function integration and the resulting reduction of tooling cost.

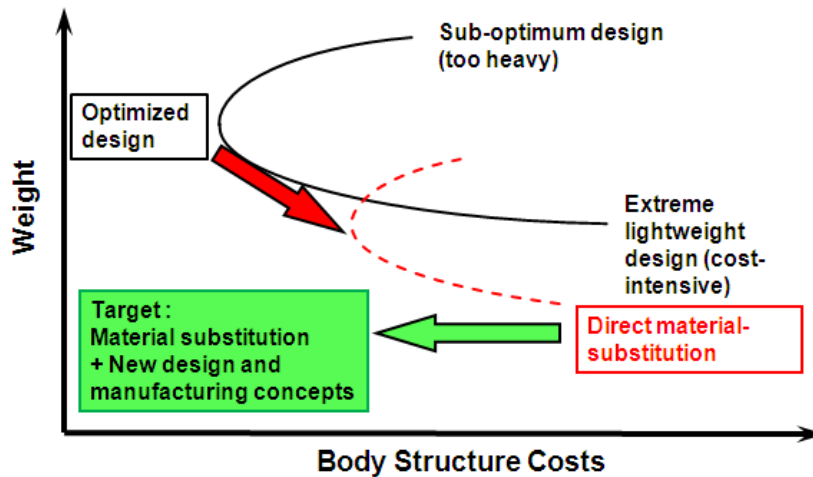

Cost-efficient lightweighting with aluminium

Significant cost reduction potential is likewise present in the total production chain of the car body when the specific characteristics of aluminium as a construction material are fully exploited by the skillful use of the advantages of aluminium in a overall system approach. Such considerations are particularly important when applying the sheet design concept, which is traditionally used for steel, but is also most favourable for the use of aluminium in high volume production.

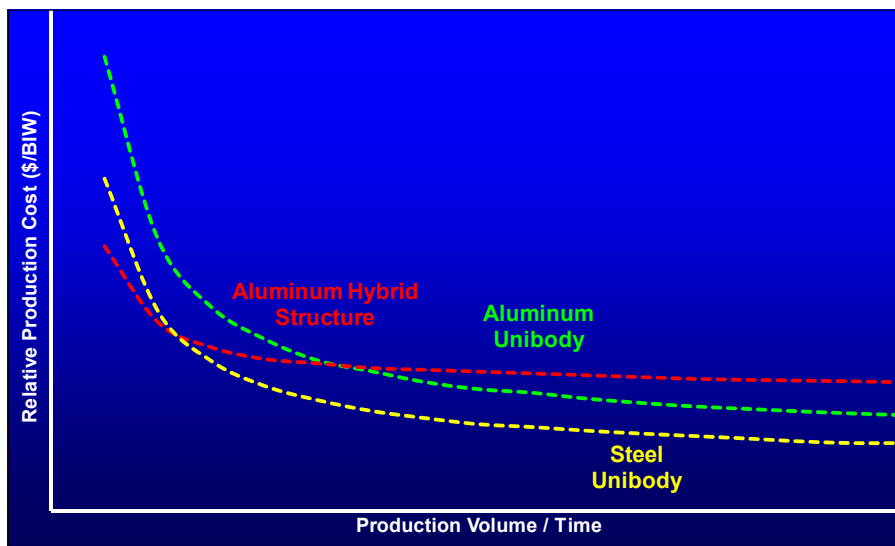

Body-in-white fabrication cost as a function of the production volume

Furthermore, the reduced body weight may open additional possibilities for weight and cost saving. Secondary weight and cost saving potentials may exist in particular in the powertrain (adaption of the engine performance). But also potential optimizations of the chassis and suspension components should be considered.

THE Aluminium Automotive MANUAL

A substantial contribution to the reduction of the total life cycle cost of an aluminium car is also provided by the recycling of the end-of-life vehicle (ELV). The proceeds from the end-of-life treatment of ELVs originate essentially from the recycling of the metals contained in the vehicle - in particular the aluminium fraction. The non-metallic materials generally end up in the automobile shredder residue ("fluff") which must usually be disposed of, liable to pay costs. The growing application of aluminium in the automotive market secures therefore in the long term also the economical recycling of ELVs. Aluminium is almost completely recovered and used again in the form of casting alloys predominantly for the fabrication of new automotive components (engine blocks, cylinder heads, transmission cases, pistons, suspension parts, etc.). The processing of the recovered aluminium scrap forms the basis of an own, economically important branch of the aluminium industry with highly developed processing techniques and methods meeting all technical and environmental standards.



Dyna Panhard (1947) with aluminium closures

4.2 The role of the envisaged production volume

The decisive factor in the selection of the optimum body design concept – and as a result the applied aluminium product form(s) – is the envisaged production volume. High volume production looks for minimum material (or parts) cost and low assembly cost, but can afford relatively high investments both in tools and manufacturing equipment. In contrast, low volume production asks for minimum investment cost whereas component and assembly cost play a less important role. The following figure shows schematically the relationship between investment cost and single parts cost for various types of aluminium components. Depending on the planned production volume, the various product forms – sheets, extrusions and structural die castings – can be used in varying proportions, sizes and shapes. In addition, the aluminium components can also be combined with steel parts, plastic elements or components produced from fibre reinforced composites.

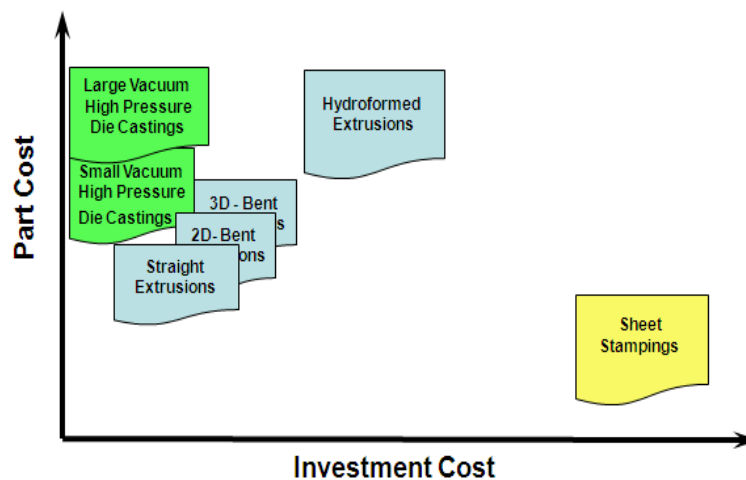

Economical factors determine the most favoured aluminium product form (schematic representation)

Taking into account all the various cost factors, a cost estimate for the different part types can be made (see below):

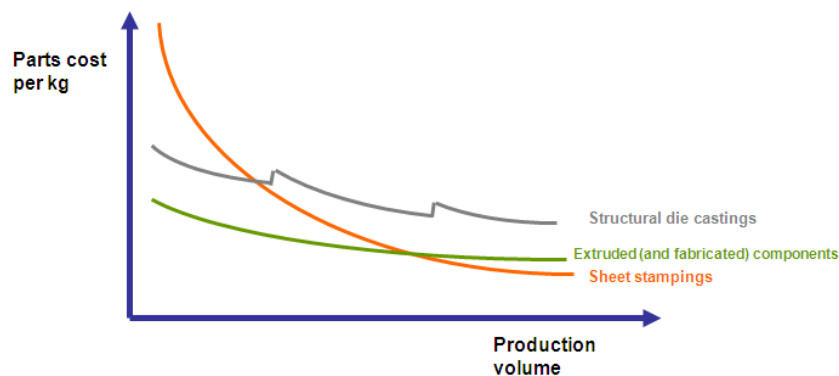

Cost of aluminium car body components as a function of the production volume (schematic)

Source: Novelis

Apart from the parts cost, also the assembly cost have to be considered. The assembly techniques suitable for aluminium are not necessarily the same as for steel from a cost and quality point of view. Thus, different approaches have to be considered also with respect to assembly and surface finishing.

THE Aluminium Automotive MANUAL

In addition, there are other parameters which may influence the actual body-in-white cost. Extruded and fabricated aluminium components or structural aluminium castings are usually supplied to the car manufacturer as finished parts, ready to assemble. Depending on the specific situation (e.g. free fabrication capacity on existing equipment), the use of extruded and cast components may result in additional cost savings at the car producer (investment in fabrication space and equipment, handling cost, etc.).

As a result of these considerations, different aluminium body concepts are being used today. An obvious solution is the application of the monocoque design – which is today the established design concept for steel car bodies – also for aluminium sheets. In production volumes, the sheet monocoque design has been first realized in the all-aluminium body of the Jaguar XJ. This model may serve as an example which was also developed with the objective to examine the feasibility of aluminium lightweight solutions for future high volume production. The Jaguar XJ body is built mainly based on aluminium sheet stampings (273 parts) with a few extruded parts (22) and cast components (15). Also the applied joining technologies are highly suited for large volume production. Due to the specific material characteristics of aluminium, adhesive bonding combined with self piercing rivets offers significant advantages compared to the resistance spot welding technology generally used for the assembly of steel bodies.



<u>Joining Technologies :</u>	Closures	Body less doors
Self pierce rivets	24	3171
Clinch spots	78	32
Adhesive (m)	1	100
MIG weld (m)	Nil	2
Weld studs (trim fix)	Nil	42
Weld studs (ground)	Nil	21
Blind rivets	Nil	180

Sheet-intensive body structure of the Jaguar XJ developed with the objective to evaluate the potential application for future high volume production

On the other hand, the AUDI space frame concept first introduced in 1994 in the A8 is primarily suited for medium production volumes. It was further improved by drastically reducing the number of parts leading to lower tool and assembly cost. Most important to note is the continued replacement of sheet stampings by extruded parts and the integration of smaller parts into large, thin-walled structural die castings.

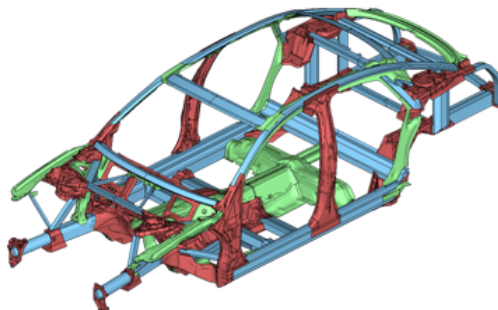

Reduction of number of parts

	D2 (1994)	D3 (2003)
Castings	50	32
Extrusions	47	58
Stampings	237	164
total	334	254

Second generation of the AUDI space frame concept (A8 model)

Apart from the self-supporting body concepts (sheet monocoque or space frame structure) suitable for medium to high volume production, there are also novel aluminium body structures derived from the body-on-frame concept. Such body architectures offer unprecedented flexibility in particular for the production of low-volume, speciality vehicles. These concepts, characterized by functional modularity and low investment needs in terms of

THE Aluminium Automotive MANUAL

manufacturing technologies, are of course also ideally suited for the application of aluminium both to produce the lower chassis frame and/or the upper space frame.

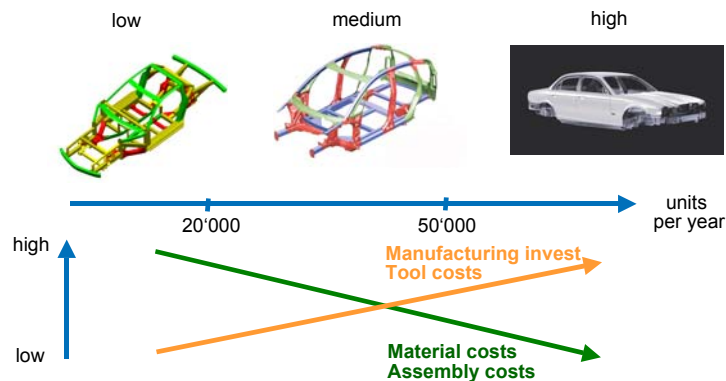

Aluminium body architecture concepts for different production volumes

Low volume production (niche models) looks for technologies with minimum tool cost. Preferred aluminium components are straight or 2D-bent extrusions, simple sheet parts, sand castings, etc., which are joined for example by MIG welding or adhesive bonding and mechanical fasteners. In small series models, aluminium is often only used for the chassis structure and combined with fibre-reinforced composite body panels.

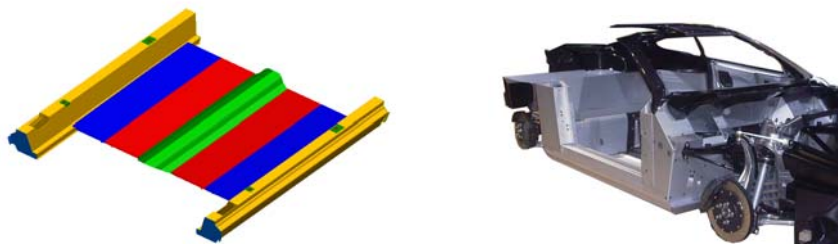

Extrusion-based design concepts for low volume production

But there is no clear optimum design solution for a specific production volume. A study which examined different space frame concepts (with the sheet volume as a variant, see below) showed that in particular for an intermediate range around 50'000 cars per year, there are different possibilities showing more or less similar on-cost over a steel body-in-white.

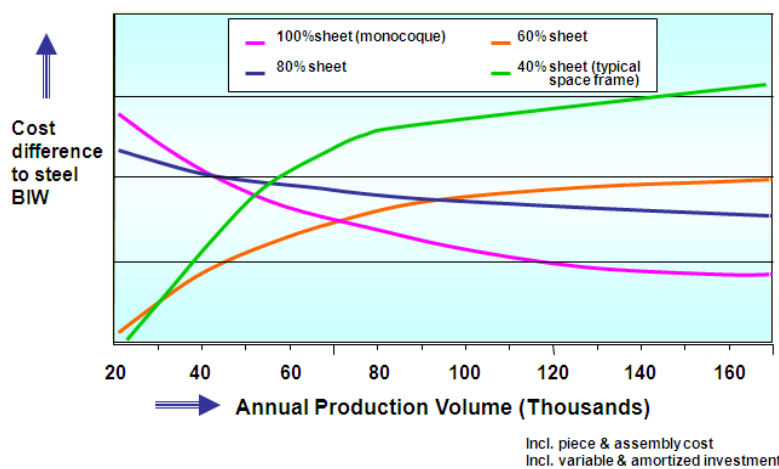

Cost difference of an aluminium body-in-white to a steel BIW as a function of the production volume

Source: Novelis

4.3 Design economics

4.3.1 Life cycle cost

In engine applications, the application of aluminium castings saves both weight and cost. But with most other applications, weight saving with aluminium induces additional production cost. However, there are also two possibilities for cost savings which should not be neglected:

- The possibilities to offset the “local” cost increase of a specific component or sub-assembly by savings in another part the vehicle (secondary cost savings).
- The full or partial compensation of the overall cost increase by the resulting improved fuel efficiency of the vehicle.

To have any significance, the commercial impact of weight saving must be considered at each stage of the vehicle life, its manufacture, use and end-of-life treatment, as shown in the figure below. Under these conditions, the added cost per kilogram can often be written off over a period ranging from one or two thirds of the life of the vehicle depending on its usage.

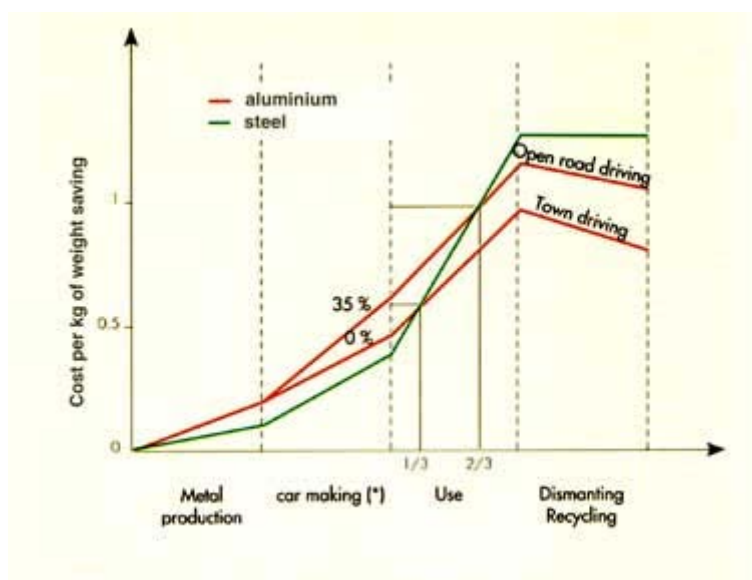

Life cycle cost of lightweighting with aluminium

Source: BriteEuram project “Low Weight Vehicle”

A weight reduction is particular interest for components and structural modules where the lower weight offers additional customer benefits, for example improved driving performance (more equal axle load distribution, lower center of gravity, faster acceleration, shorter braking distances), increased comfort (smaller unsprung masses) or easier handling of hang-on parts (doors, tailgates, hoods). Under today’s boundary conditions, the “value” of a saved kilogram of car weight varies between one and five Euro, but may be also higher depending on the specific circumstances. The limiting value which is accepted by the market depends on the specific type of vehicle, the functionality of the component and its location in the vehicle. In general, the value of lightweighting decreases from the front to the rear and from the top to the bottom of the car body.

4.3.2 Relationship between weight and cost

Given the fact that the price of a kilogram of aluminium alloy is three to five times higher than the price of steel and keeping in mind that aluminium can save up to 50 % in weight, the cost of an aluminium solution is roughly double that of steel. Thus it is of prime importance to minimise the metal quantity needed in production

The extra cost per kg saved, that can be defined as the additional cost of the aluminium solution compared to that of the steel solution divided by saved weight, is very sensitive to the relative weight saving (see the example of a bonnet below). The thickness of the applied aluminium sheets (i.e. the total weight reduction potential) has a big influence.

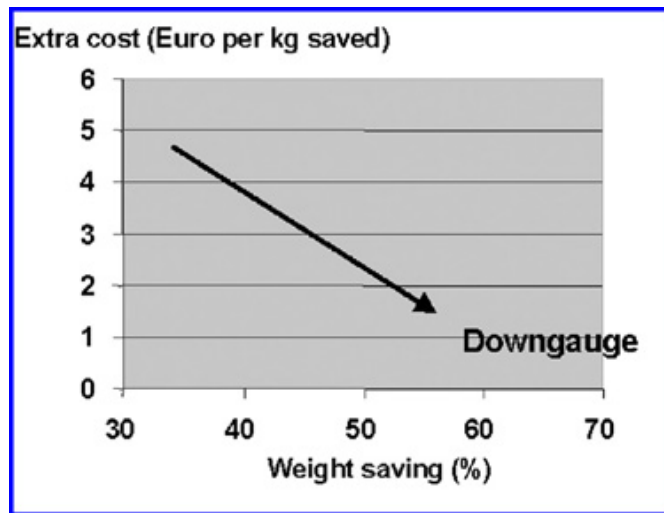

Extra cost vs. weight saving for an aluminium bonnet (schematic graph)

If the limit for the acceptable extra cost of lightweighting is around 4 €/kg (and optimally below 3 €/kg), it is necessary to achieve at least 40 % weight saving. Down gauging and minimising the metal quantity used in production are the main levers to reach this target.

The extra cost of aluminium solutions is higher when compared to a high strength steel solution which is already offering a weight reduction compared to mild steel (see example below).

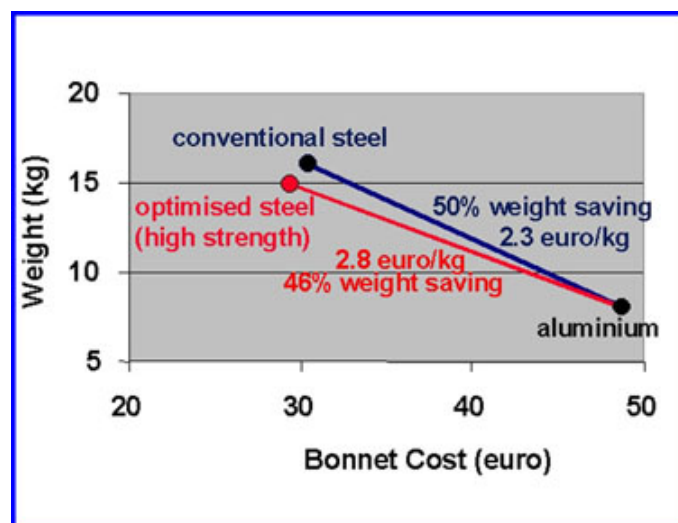

Cost for a bonnet (schematic)

4.4 Cost-efficient design solutions with aluminium

4.4.1 Introduction

Some conditions for the success of aluminium automotive designs are described below. Pure material substitution is possible in closure applications, but it is generally not the favoured path to the optimized lightweight design with aluminium in structural applications. The particular properties of aluminium must be combined to get the very best of performance and this can involve changing the way in which components or sub-assemblies are made. Key success factors are:

- Integration of the specific characteristics of aluminium into the design approach, a direct replacement of steel by aluminium would be a misguided approach.
- The design approach must be globalised by looking at the component in terms of its location within the specific sub-assembly and its function.

In addition during the design phase, some important tasks should be carried out:

- The design concept must be optimised to minimise both weight and final cost while fulfilling all the technical requirements (stiffness and fatigue characteristics, crash performance, etc.).
- Numerical simulation methods should be used both for the optimisation of design (e.g. the dimensioning of the crash management system) and manufacturing (stamping, casting, etc.). Such an approach minimises the necessary qualification tests and allows a faster optimisation of tool design and processing conditions.
- Furthermore, a detailed evaluation is necessary if and how far processing techniques can be used which are compatible with existing production lines.

In many cases, aluminium is compatible with existing production lines. This is valid in particular for aluminium sheets. Forming, assembly (with some limitations) and surface treatment (aluminium is compatible with steel paint lines) can be carried out using the same manufacturing equipment as for steel. There is a need for a slight adaption of the processing conditions, but there a little or no additional manufacturing costs.

A decisive factor is the selection of the proper aluminium product form (e.g. sheet, extrusion or cast part) as well as the alloy and temper. Optimised aluminium solutions often result from the integration of different parts and/or additional functions into a single component. The aluminium bumper beam is an interesting example for the integration of specific characteristics of the aluminium technology in order to achieve a cost-efficient solution:

- Use of an aluminium extrusion instead of a pair of stamped sheets
- Adaption of the cross section design and elimination of the need for joining within the section

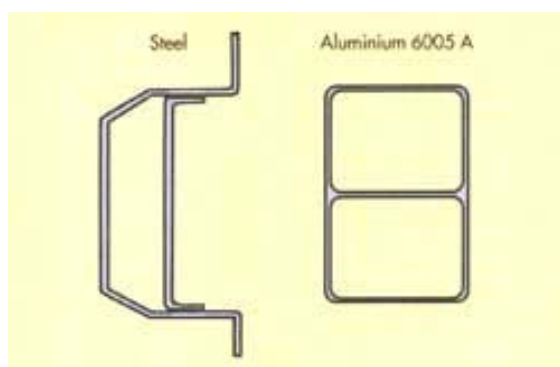

Bumper beams

THE Aluminium Automotive MANUAL

Weight savings can translate into cost savings when a design is conceived:

- to minimise the quantity of material,
- to integrate different parts into a single component (eliminate joining processes)
- to combine different functions so as to rationalise the component production process and the number of joints.

The integration of functions allows to reduce the number of parts as well as to reduce the number of fabrication steps (forming, joining, machining, etc.).

The choice of the alloys and tempers depends on the physical and chemical demands of the final application. However, the selection of the appropriate aluminium alloy and temper is not just a matter of selecting a certain chemical composition and a specific fabrication process which will ensure the envisaged material characteristics. The alloy selection must be made keeping in mind the product form (casting, rolled or extruded semi, forging, etc.) as well as the subsequent fabrication processes, in particular any surface treatment processes.

4.4.2 Stamped sheet components

Except for the sheet thickness, aluminium and steel sheet solutions will often look alike. In principle aluminium car body panels are produced using the same forming methods and equipment as for steel panels. Also the tool technology is similar. Aluminium-specific characteristics have to be considered only in the detailed tool design and the selection of appropriate processing conditions. The main difference in sheet assemblies will be the applied joining technique. Cost-efficiency can be achieved in particular by:

- Using alloys showing significant age hardening during the e-coat bake. Proper alloy selection may allow significant down gauging of the applied sheets and thus cost savings. Today, a separate heat treatment of the body-in-white is not used anymore.
- Limiting the number of joining methods used on a part/module. The application of multiple joining techniques leads to an increase of time cycle and investments.
- Using existing surface treatment lines. Only minor modifications are necessary, there is no need to invest in new lines.

General fabrication guidelines

During storage and transport of aluminium coils, sheets or formed panels, some rules have to be kept in mind (apart from an adequate packaging method):

- Environmental conditions leading to condensation of humidity on the sheets have to be avoided since this may cause water stains and/or a corrosive attack.
- During transport, any friction between individual sheets must be prevented because friction effects may produce local surface damage by adhesion (“galling”). For the transport of formed panels, special racks have proved to be most suitable.
- A clean working environment must be ensured as dirt particles, aluminium flitters, etc., are easily pressed into the relatively soft aluminium surface.
- During destacking of the sheets as well as during transport in the press line, the formation of scratches must be avoided.

Also in the press plant, only minor adoptions of the tool design and stamping conditions are necessary. Nevertheless, special care is necessary when changing from steel to aluminium:

- When designing for aluminium stampings, it is generally good practice to avoid sharp features (if they are not necessary for the fit or function of the panel). In addition, deep drawing depth should be avoided, if possible.
- The aluminium sheet surface is softer and more sensitive to scratches, dents, etc., than the steel sheet surface. Therefore aluminium car body sheets are usually supplied coated with oil or preferentially with a dry lubricant ensuring appropriate corrosion protection and protection against handling and transport damage.
- The adaptation of stamping tools to a more aluminium-friendly design is recommended, but does generally not present any major problems. Compared to stamping tools laid out for steel, it is usually necessary to adjust the geometrical arrangement and the form of the draw beads.
- An important point is the correct consideration of the springback behaviour in the tool layout process. As a consequence of the lower modulus of elasticity, spring back will be stronger for aluminium sheets compared to steel sheets with similar strength levels. This effect – which is normally considered in the numerical simulation programs for aluminium forming – can also be somewhat reduced by appropriate measures with respect to material selection and/or tool design.
- Furthermore the blank size and shape may have to be adapted for the aluminium-specific forming characteristics. The evaluation of the use of shaped blanks to minimise scrap and cost is recommended.
- When cutting blanks from aluminium sheets or coils as well as during trimming of formed sheet parts, it is most important to avoid the formation of an excessive bur

THE Aluminium Automotive MANUAL

and in particular the occurrence of aluminium slivers. Slivers as well as sheared off bur particles will damage the sheet metal surface and lead to rejects or require extensive manual rework.

- In some cases, it may be necessary to locally grind and polish a formed panel to avoid complete rejection. In particular when using dry grinding and polishing methods, a strongly disturbed surface layer develops. Consequently the stability of the interface between the aluminium surface and the paint is reduced and the painted panel may be prone to filiform corrosion. Therefore with respect to long-term corrosion resistance in the painted condition, it is more favourable to use wet grinding and polishing methods followed by an alkaline etching treatment which removes the locally disturbed, thin surface layer.
- The achieved stamping rates with aluminium are equivalent with those for steel. In general, there are also no differences with respect to tool inspection intervals and tool maintenance.
- For aluminium stamping tools, the same materials can be used as for steel. However, a smoother tool surface quality is preferred. Very good results have been achieved with surface coatings produced for example by nitrating, chromium plating or vapour-deposition of titanium carbide (TiC) or titanium nitride (TiN).
- For aluminium sheet forming, many different lubricants based on mineral oils are available, most of them also proven in steel sheet forming.
- Washing of the blanks is generally not necessary. If necessary, stamped aluminium panels are degreased using an alkaline solution. For aluminium parts which have to be subsequently spot welded, a pickling treatment is advisable to remove the relatively thick and inhomogeneous oxide surface layer produced by prior thermal and mechanical processing steps.
- Hem flange bonding can be done onto the lubricant without the need for any surface treatment of the aluminium sheet. When used in structural assemblies, however, aluminium panels should be conversion-treated in order to guarantee the long-term stability of adhesively bonded joints. The original surface oxide layer is removed and replaced by a new, more stable oxide layer. Today, properly surface pre-treated materials are increasingly produced by the aluminium sheet supplier eliminating the complex and expensive piece by piece surface treatment of the aluminium components.
- Normally, the dry lubricants are washed off only during the alkaline degreasing of the assembled car body before zinc phosphatisation. Thus, it must be ensured that the selected combination of surface pre-treatment and lubricant is compatible with the joining technologies applied in the assembly plant, in particular with the used adhesives. In addition they must also be compatible with the surface treatment systems used in the paint shop. Any potential interference with the lacquering process must be eliminated since the complete removal of the dry lubricant in the washing step cannot be guaranteed with absolute certainty.

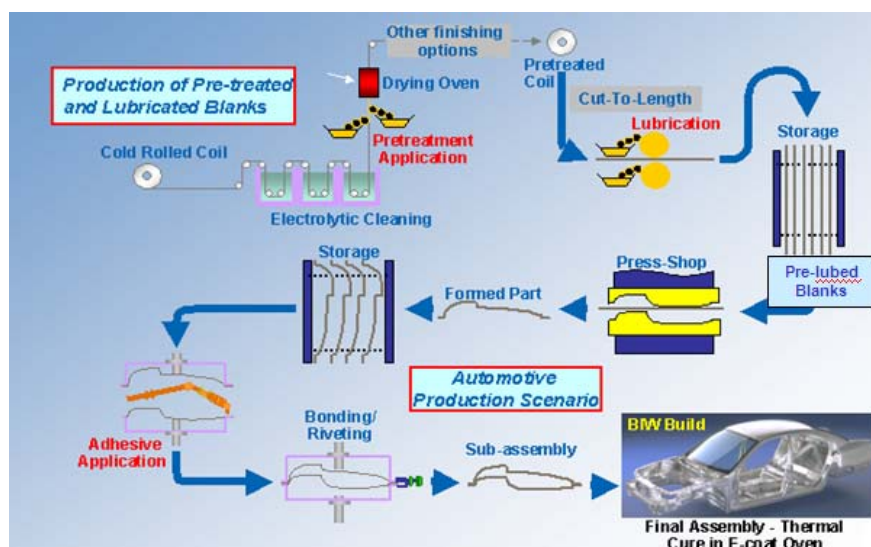

Application of surface treated and lubricated aluminium sheets

Material supply and scrap management

Aluminium sheets are generally supplied to the press shop in the form of coils and/or rectangular blanks. In the past, mainly aluminium blanks were used, in particular for outer body applications. Nowadays, coil supply is also more and more standard for outer body applications.

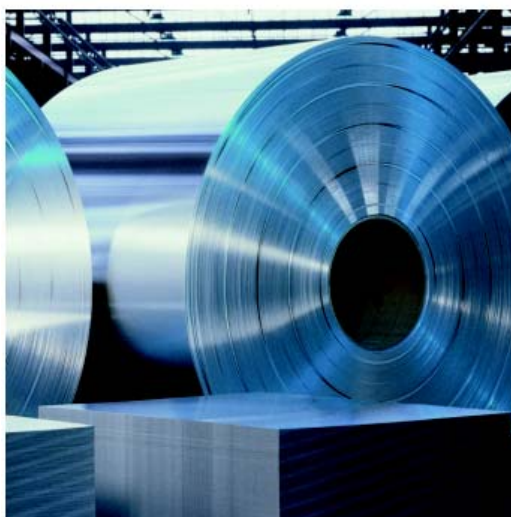

Aluminium sheet supply in the form of coils and rectangular blanks

For cost-efficiency, it is of prime importance to minimise the metal quantity needed in production. Apart from the selection of the minimum sheet thickness required for the envisaged application, the reduction of the blank size (or coil width) is another lever to reduce cost for stamped parts.

Proper management of the production process scrap, both in regard to minimizing the amount produced, and in its segregation by alloy, is a key to the economic use of aluminium for automotive part production. For maximum value preservation, aluminium scrap generated in the press shop during blank cutting and trimming of the shaped panel must be collected separately from the steel scrap. Aluminium scrap that is sorted according to alloy classes is often returned to the sheet supplier and directly used for production of new car body sheets (closed loop recycling). Mixed aluminium scrap is usually fed into the general aluminium recycling system. However, scrap segregation is not always easily achieved in automotive stamping plants since the scrap from all operations, including aluminium and steel, is generally handled through a common conveyor system. Magnetic separation can be used to remove the steel from the aluminium and there is now emerging technology for alloy specific separation.

Aluminium scrap has a much higher value than steel scrap, but the difference between the initial material cost and the scrap value is still significant. Thus the generation of scrap should be kept to a minimum (also keeping in mind the handling and transportation cost). This is especially important in the production of stamped components where the scrap can be up to 50% of the original weight supplied.

Material cost can be significantly influenced by the choice of blank shape, orientation and size. For the designer, this means paying attention to the position and shape of split lines between panels in order to minimise scrap. An important cost reduction measure is also the optimisation of the blank size by numerical simulation of stamping process.

For specific applications, in particular bonnets, cost savings can be achieved by the choice of curved or trapezoidal blanks instead of rectangular blanks:

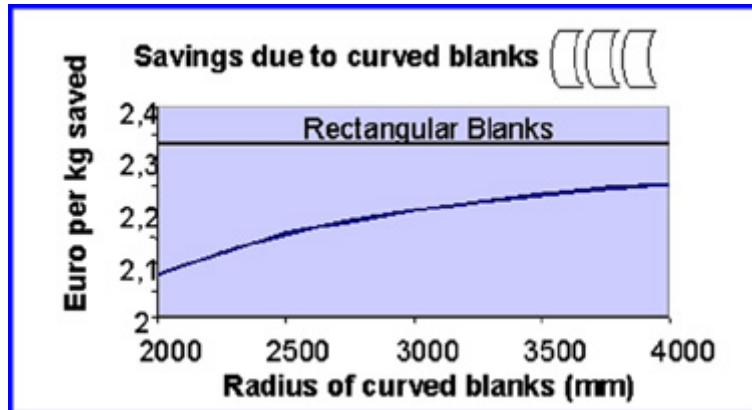

Bonnet example: Cost reduction when using curved blanks (chevrons)

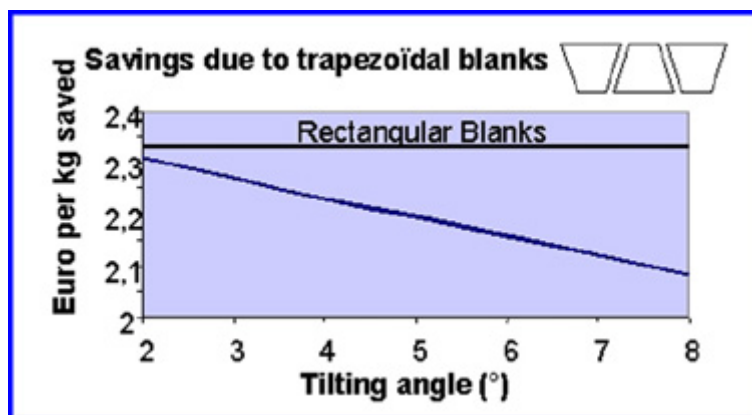

Bonnet example: Cost reduction when using trapezoidal blanks

With the market introduction of shaped aluminium blanks in any arbitrary geometry produced on highly automated laser cutting lines in the rolling mill, additional opportunities are opened. The quality of the laser cut edge allows the direct introduction of the blank into the stamping tool without the risk of surface blemishes due to excessive sliver formation. As a consequence of the omission of the blank cutting operation, substantial cost reduction potentials may result in particular for low to medium volume production (elimination of the blanking tool, more effective process scrap handling and recycling, etc.).



Production of laser-cut shaped blanks at the aluminium sheet supplier

Source: Novelis.

Room temperature stamping and forming of aluminium

A great many automotive are manufactured from AlMg (5xxx) and AlMgSi (6xxx) series aluminium sheet. Room temperature stamping is the most cost effective route for most panels.

For stamping of aluminium panels, mechanical or hydraulic presses with upper and lower tools are generally used. In a pure stretch-forming process, the blank is firmly clamped at the outer edge by the blankholder and the shaping is achieved by increasing the surface area while reducing the sheet thickness. During pure deep-drawing, the sheet metal slips underneath the blankholder and the sheet thickness remains more or less constant. The decisive factor influencing the result of the forming step is an accurate control of the material flow under the blankholder. Aluminium alloys exhibit generally an inferior stretch-forming capability compared to steel. Therefore recent developments aiming at a more precise control and/or local variation of the drawing and blankholder forces (for example by using a segmented blankholder) or forming with variable blankholder pressure are of special importance.

It is often mistakenly assumed that only hydraulic presses are suited for forming of aluminium parts. It is true, however, that the majority of pneumatic and hydraulic drawing cushions in mechanical presses are not able to produce a defined, reproducible hold-down force. Severe impact shock and force peaks have a negative influence on the sensitive aluminium forming process. Impact shock, for example, can lead to a work-hardening under the blankholder or – after painting – leave visible marks on the surface of the sheet. Therefore, a freely adjustable hydraulic drawing cushion with pre-acceleration is an absolute requirement for the deep drawing of difficult parts on mechanical presses.

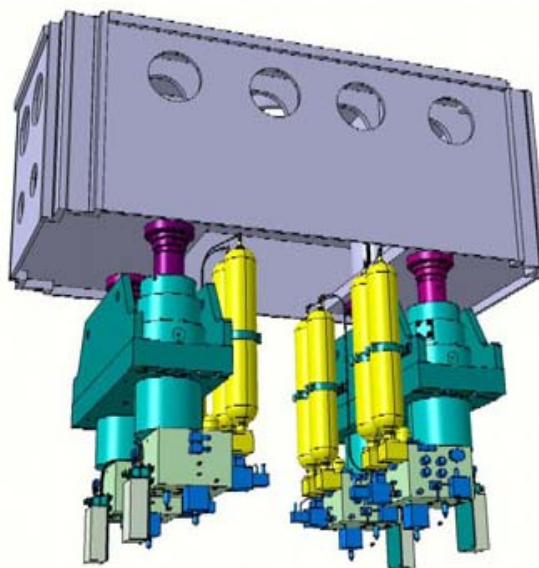

An all-hydraulic modular drawing unit

Source: Schuler

If splitting or wrinkling is encountered, it is generally possible to improve the forming window by a combination of one or more of the following well known strategies (not in order of priority):

1. Modify radii at critical locations of stretched-in details
2. Modify draw radii
3. Modify blank shape and size to change material movement in first draw operation
4. Optimise blank positioning with respect to the rolling direction of the coil

THE Aluminium Automotive MANUAL

5. Optimise blank lay
6. Try alternative lubricant
7. Modify blank holder force
8. Modify or add draw bead features on blank holder
9. Add shallow features on non visible surface to reduce wrinkles in critical regions
10. Optimise roughness of tooling
11. Check roughness of blanks
12. Change alloy / thickness of blank

Contrary to standard steel practice it is generally better to start with a slightly undersized blank for draw operations with aluminium, and then to gradually increase the blank size until splitting occurs in order to assess the forming window during initial tool setting. This approach acknowledges the lower draw performance of aluminium than steel. In addition, this approach automatically identifies the smallest blank size (lowest material cost) that can be used to manufacture the parts.



Versatile hydraulic press line for manufacturing aluminum components

Source: Schuler

Factors influencing build tolerances

Build tolerances are a function of variations in the geometrical shape of the part and the assembly process. This section will not discuss the management of assembly process variation since the same principles apply to aluminium as for other materials.

a) Spring back

The shape of stamped parts is influenced by spring back. Spring back is caused by the release of elastic strains introduced by the shaping operation. The magnitude and degree of release of the elastic strains is a function of the form of the part and the material properties. Spring back is most severe during the unloading phase of bending operations

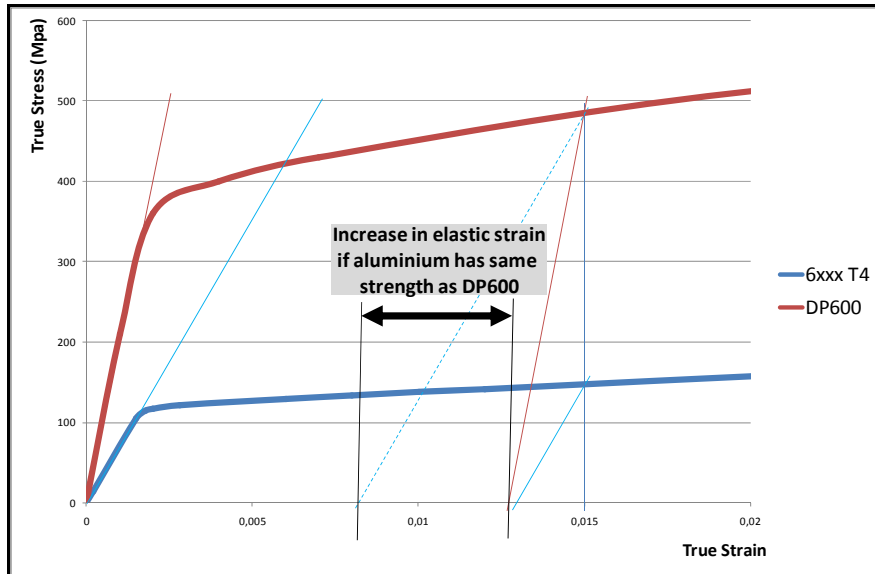

The simple case of a tensile test specimen illustrates the principles related to material properties. The elastic modulus influences the size of the elastic part of the total strain. Additionally, as the strength of the material increases, so does the elastic part of the total strain. Parameters influencing aluminium spring back (SB) include:

Elastic Modulus (E)	SB inversely related to E
Yield Strength (YS)	SB related to YS/E
Material Thickness (t)	SB inversely related to t (SB can go negative) ref. JEM1321 IMechE 2009
Hardening Model	Isotropic, Kinematic or Mixed
Anisotropy	
Friction	
Temperature	SB inversely related to forming temperature
Tool / Part Geometry	SB related to Punch and Die corner radii SB related to tool clearance/flange length
Drawing operations	SB inversely related to Blank holder force
Bending Operations	Flanging (convex and concave), folding, tube bending etc.

Numerical analysis is used to assess the likelihood of problems with spring back for a given geometry. The actual part shape, however, may be different to the simulation results owing to the large number of influencing parameters that encompass material, product form and process parameters such as friction. The hardening model (Hill48) used by default in most explicit FE stamping codes is usually not accurate enough for aluminium.

b) Thermal processes

A vehicle structure is subjected to temperature variations both during manufacture and in-service life. Small variations in ambient temperature during production and assembly are generally accommodated in the design of datum features (one circular hole and one slot for example). This is standard practice for mono-material assemblies. Additional measures may be necessary where materials having a dissimilar linear expansion coefficient are assembled together in order to avoid excessive build tolerances and thermally induced straining in locations subjected to large temperature variations.

Major sources of thermal loading are:

1. Paint cure cycles
2. Engine compartment (exhaust manifold and catalytic converter)
3. Heat from the sun
4. Brake disks.

Paint cure cycles can introduce a temperature variation of up to 185°C from normal assembly ambient temperature. In all-aluminium designs, no distortion results from typical automotive paint bake cycles (170-200°C for 15-20mins). The following measures are recommended for multi-material structures:

- ⤴ Skin panels may be attached, but not assembled rigidly to the structure (if it is of a dissimilar material) for paint cure. Final assembly may be completed at normal ambient temperature.
- ⤴ Limit the interface (if possible) to zones that are non-visible.
- ⤴ Add a thermal analysis validation load case.

Cost-efficient manufacturing processes for aluminium sheets

Many advanced forming technologies are available for aluminium. These technologies should be considered in particular for small series and niche applications when the design requires a high degree of functional integration or the use of higher strength alloys that may be difficult to stamp into the required shapes at room temperature. Their aim is an extension of the conventional forming limits of aluminium materials and/or to take into account manufacturing aspects looking for improved quality and cost efficiency (in particular reduction of the tooling cost).

Hydromechanical sheet forming or rubber press forming require, for example, only a mould half. Other advantages of these forming techniques are the ability to achieve larger drawing ratios, a better accuracy of shape and dimensions or a more favourable distribution of residual stresses. The integration of a pre-stretching operation during hydromechanical deep-drawing, for example, increases the dent resistance of the final panel which can be of particular interest for relatively flat stampings such as roofs.

A second possibility to influence the forming operation is the exploitation of the temperature dependence of the forming characteristics of aluminium alloys. In principle, forming at ambient temperature is unfavourable for aluminium alloys. Both forming at low temperatures (-50°C to -200°C) and at higher temperatures (above 150°C to 200°C) offers advantages. Warm forming in the temperature range between 200°C and 300°C and superplastic forming (at temperatures above 450°C) are of high interest, in particular for AlMg alloys, but also other aluminium alloy systems. Forming at these temperatures using properly adapted forming speeds enables the exploitation of the significantly higher values of elongation to fracture under these conditions. In warm forming, the elongation to fracture can be increased to the range 50 to 100%; with the slower superplastic forming process 300 to 500% can be reached, however, at the expense of cycle times of five or more minutes. Warm forming is carried out with a conventional tool, superplastic forming requires only a mould half because of the lower forming forces. But for both processes, a satisfactory solution of the lubrication problem has to be found, i.e. especially the manufacturing of sheet panels with high surface quality requirements requires special efforts. Variants of the superplastic forming process with considerably shorter cycle times like the QPF technology (QPF; Quick Plastic Forming) are of increasing interest today.

Furthermore, interesting effects can be observed when extremely high forming speeds are applied. Deformation rates in the range of 10^4 to 10^5s^{-1} can be achieved for example by explosion forming or in a electro-magnetic pulse forming operation: because of the good electrical conductivity, electro-magnetic pulse forming is particularly suited for aluminium. The application of such forming speeds not only increases the forming limits of aluminium sheets by a significant amount permitting for example the introduction of very sharp design lines, but suppresses for AlMg alloy materials also the formation of the Lüders lines of the type B which normally prevents their application for outer body panels.

a) Hydroforming

THE Aluminium Automotive MANUAL

In hydraulic deep drawing, the blank is pressed into the die by a fluid medium under pressure in order to achieve the final contour. In the process, the blank can continue to flow from the flange area as in conventional deep drawing. Hydraulic deep drawing is especially well suited for the forming of spherical shapes. In addition, two blanks can be formed at the same time (interior high-pressure forming of blanks). In this process a liquid medium is supplied between the blanks; the upper blank is pressed into the upper cavity/form and the lower blank into the lower cavity/form. The two cavities can be different, but there must be an identical flange gradient to ensure proper sealing of the blanks.

Advantages for sheet applications:	Disadvantages for sheet applications:
Re-entrant (under-cut) geometrical features possible.	High Cycle time / process cost
Zero friction punch surface. Reduces localisation of strain until die features are contacted	Expensive specialised equipment
Lower localised strains. Hydrostatic pressure on entire exposed blank surface spreads the stretching strain, whereas, a metal punch in a conventional process will generate localised high strains where initial contact is made with the blank.	Wet environment
Fewer draw operations. Multiple draw operations may be eliminated because of even distribution of strain on entire exposed blank surface since sharp features are stretched in upon contact with the die surfaces when draw ceases.	
Reduced spring back.	

In hydromechanical deep drawing, the blank lies on a water-filled cushion that is only sealed in the flange area by means of a hold-down ring. A punch that provides the contour impacts the blank and continues its downward motion until the water pressure, elevated by the displaced medium, completely expands the blank over the punch. The resulting surface quality is superior since the outside of the component has no direct contact with the tool. Higher drawing ratios can be achieved by this method than by conventional deep drawing. In addition, a lower half of the die is not necessary. Since the cycle times are faster than in hydraulic deep drawing, this method usually involves cost savings for small and medium-sized production lots

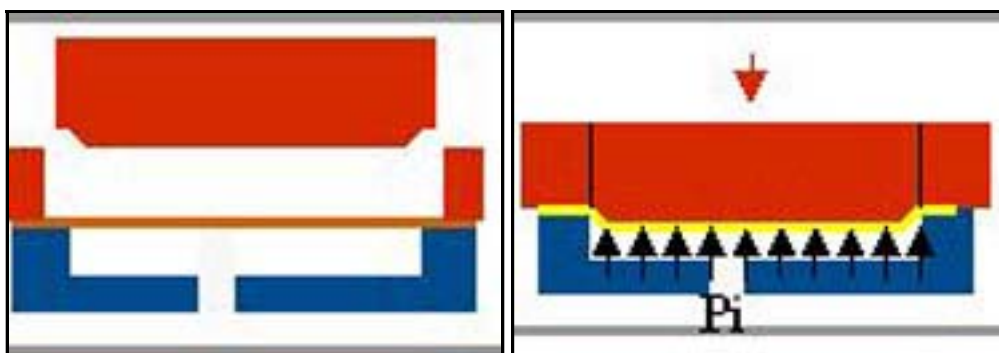

Hydromechanical deep drawing

Source: Schuler AG

A variant of this process is active hydromechanical deep drawing. This technology differs from the hydromechanical deep drawing process in that the blank is initially pre-stressed in the opposite direction of the punch movement. Thus the component undergoes some work hardening that would be difficult to achieve using conventional deep drawing in the middle section of a component. In addition, as is also the case in hydromechanical deep drawing, larger drawing ratios are achieved as compared to conventional deep drawing. Since the cycle times are faster than in hydraulic deep drawing, there is generally some cost savings for smaller and medium-sized production lot sizes.

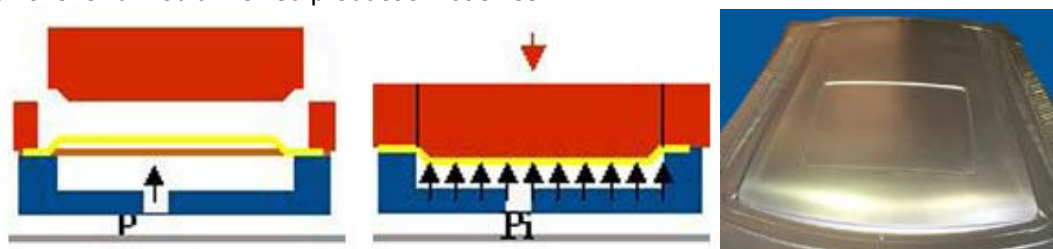

Active hydromechanical deep drawing (example: Maybach roof)

Source: Schuler AG

Aluminium can benefit more than steel from the increased forming window these processes deliver. Sheet hydroforming delivers a higher draw ratio from the material than conventional stamping. This is particularly beneficial for medium and high strength aluminium grades since they have lower 'r-values' than equivalent strength steel. Also the higher work hardening exponent 'n' of wrought aluminium alloys may be exploited to increase the material strength over most of the component.

b) Thermally assisted forming of aluminium sheets

The formability of aluminium sheet alloys is generally good enough for most applications in vehicle structures and skin panels. However, panels with tight features and a significant draw depth may not be possible in medium and high strength aluminium alloys with conventional stamping processes. But it is possible to obtain very different forming properties from aluminium if it is stamped at a different temperature. As an example, the room temperature elongation of EN-AW 2024 can be more than doubled if it is stamped at 250°C.

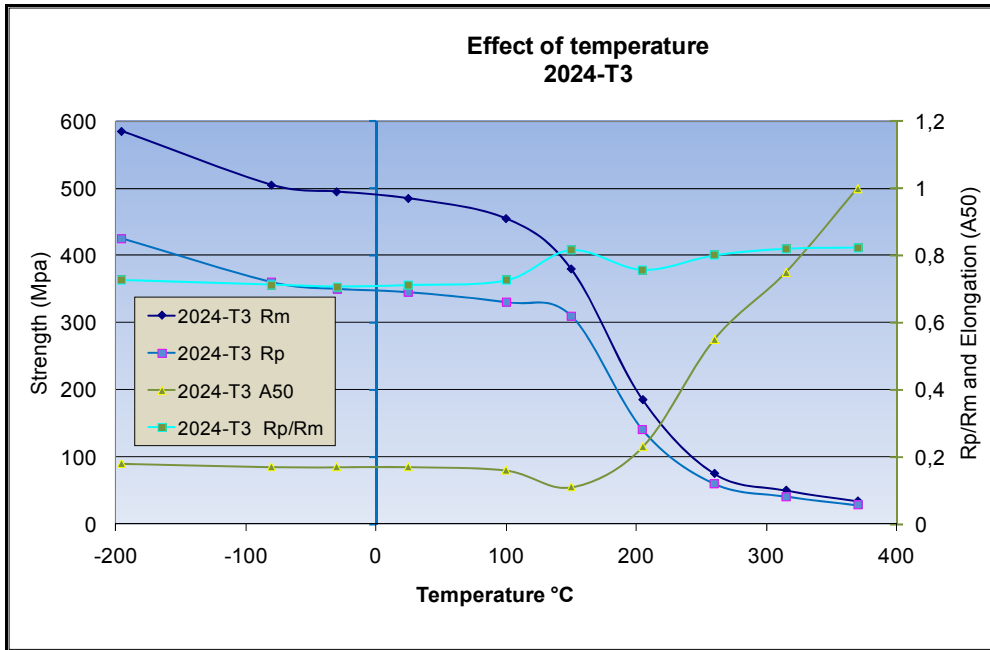

There are essentially three methods for thermally assisted sheet forming of aluminium, but with many different variations:

1. Superplastic forming

- a. Forming temperature $\approx 550^{\circ}\text{C}$
- b. High pressure gas forms sheet over heated punch, or into heated die cavity.
- c. Cycle time > 30 minutes
- d. Maximum elongation 100 – 2000%

2. Quick plastic forming

- a. Forming temperature $\approx 500^{\circ}\text{C}$
- b. Hot deep drawing assisted at end of stroke by high pressure gas to form-in details on punch surface.
- c. Cycle time > 5 - 10 minutes
- d. Maximum elongation 100 - 300%

3. Warm Forming

- a. Blank pre-heat to approximately 250°C just prior to draw operation
- b. Heated blank holder and in some cases a pre-heated blank is quenched as it is drawn over a room temperature punch.
- c. Cycle time > 20 seconds
- d. Maximum elongation 40-150% (function of alloy, forming speed and lubrication)



Superplastically formed closure panels

Source: SuperformAluminium

THE Aluminium Automotive MANUAL

The superplastic forming process offers an effective alternative for niche vehicle manufacture. Forming at 500°C greatly enhances the formability of the sheet allowing the realization of concave or convex shapes without any spring back. The sheet is forced onto the tool using air pressure which ensures an A class surface quality as the external panel surface never comes in contact with any tools. Using this unique process enables:

- Faster market introduction of vehicles to the market whilst retaining all the inherent qualities of a metal bodied car
- Lower investment costs: Cast single surface tools are cost effective and can be used for production quantities
- Design large complex panels up to 3000mm x 2000mm x 600mm deep in one piece without the need for high investment.

Single surface tools enable quick manufacture and eliminate the need for a try out period. The tools for prototype manufacture can also be used for production as they are capable of producing in excess of 20,000 panels. After forming the sheet reverts back to its room temperature properties and still has 22% elongation to enable flanging and clinching operations.

General Motors Corporation patented a process that forms superplastic aluminium alloy sheet, preferably AA5083, at elevated temperature. The process – referred to as Quick Plastic Forming – enables to make more complex forms for production models, shapes previously limited to concept and low-volume niche vehicles.



Chevrolet Malibu Maxx liftgate produced with the QPF process

Source: Alcoa

THE Aluminium Automotive MANUAL

Advantages of Superplastic & Quickplastic forming:	Disadvantages of Superplastic & Quickplastic forming:
Very complex details can be stretched into the part owing to the elongation available before fracture at these temperatures.	High Cycle time / process cost
Zero friction punch or die surface during gas forming. Reduces localisation of strain until die or punch features are contacted	Expensive specialised equipment
Potential to integrate several panels into one stamping , eliminating assembly cost, visible joints and discontinuities.	Final panel is in soft condition. Heat treatable alloys may require several thermal treatment cycles if higher strength is required.
Fewer draw operations. Multiple draw operations may be eliminated.	Special high temperature lubricant
No spring back.	More sensitive to galling and tooling pollution defects than room temperature stamping.

High temperature forming offers tremendous shape capability. However, automotive examples are generally limited to low volume bonnets, boot lids and door inner panels because of cost. Thus a possibility to exploit the potential of thermally assisted forming would be the application of the warm forming process. But this technology is not yet applied in industrial practice.

Advantages of warm forming (<350°C):	Disadvantages of warm forming (<350°C):
Increased depth of draw possible compared to room temperature stamping.	Higher Cycle time / process cost than room temperature stamping
Cold punch introduces work hardening into quenched material. Heat treatable and non-heat treatable alloys deliver good post forming material strength.	Demands a more complex tooling development program to avoid tooling locking, since thermal history of blank holder different to punch during process start-up and shut-down. Increased complexity of blank holder (heaters and expansion joints) and punch (cooling system).
Potential to integrate several panels into one stamping, eliminating assembly cost, visible joints and discontinuities.	Higher energy consumption
Fewer draw operations. Multiple draw operations may be eliminated in most cases.	Special high temperature lubricant is needed
Reduced spring back in zones heated by blank holder.	More sensitive to galling and tooling pollution defects at heated locations than room temperature stamping.
	Aluminium becomes sensitive to strain rate at these forming temperatures, requiring additional material characterisation for modelling of the stamping operation.
	Coupled thermal and mechanical modelling is needed in order to predict the temperature history and hence the instantaneous material properties of the material drawn off the blank holder surface.

c) Solution heat treatment and ageing

Heat treatable alloys (2xxx, 6xxx and 7xxx series) are usually solid solution heat treated (SSHT) by the aluminium manufacturers to deliver a guaranteed stamping capability.

The surface quality of AlMgSi outer skin material is particularly sensitive to the SSHT schedule. Material manufacturers carefully optimise this process in order to obtain a guaranteed minimum paint bake response, high surface quality and hemming capability. An important criterion for practical application is the consistency and stability of the relevant material characteristics. AlMgSi sheets are supplied in the solution heat treated T4 temper or increasingly in the pre-aged (“stabilized”) T4 condition (PX). The T4 condition is by definition not stable and even storage at ambient temperature leads to a slow strength increase caused by the starting precipitation of the alloying elements which are initially dissolved in the aluminium crystal lattice. The changes in strength level are largest in the first hours after solution heat treatment and quenching. This process phase is completed before the material is actually delivered to the customer. After delivery, copper-free AlMgSi only show a very slow hardening effect with increasing storage time at room temperature. For the Cu-containing materials a somewhat stronger strength increase is observed, which can negatively affect the forming behaviour after extended storage (depending on alloy and temper approximately six months or more). It is not recommended to use additional SSHT processes on skin sheet qualities.

However, the effect of a SSHT can be deliberately exploited for structural (non-visible) application using ultra-high strength aluminium alloys of the AlZnMg(Cu) or AlCu(Mg) series.

THE Aluminium Automotive MANUAL

Most of the natural ageing takes place within first few hours of SSHT and then continues during the first few days after quenching.

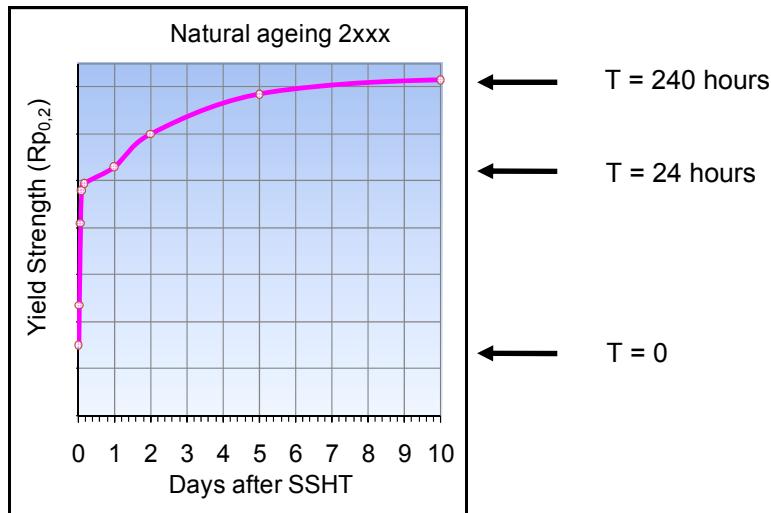

If an increased formability is needed for manufacturing, non-visible components can benefit from applying a crude SSHT process, followed immediately by the stamping operation. The resulting stampings will increase in strength from an unstable 'W' temper to approximately T4 after a few days.

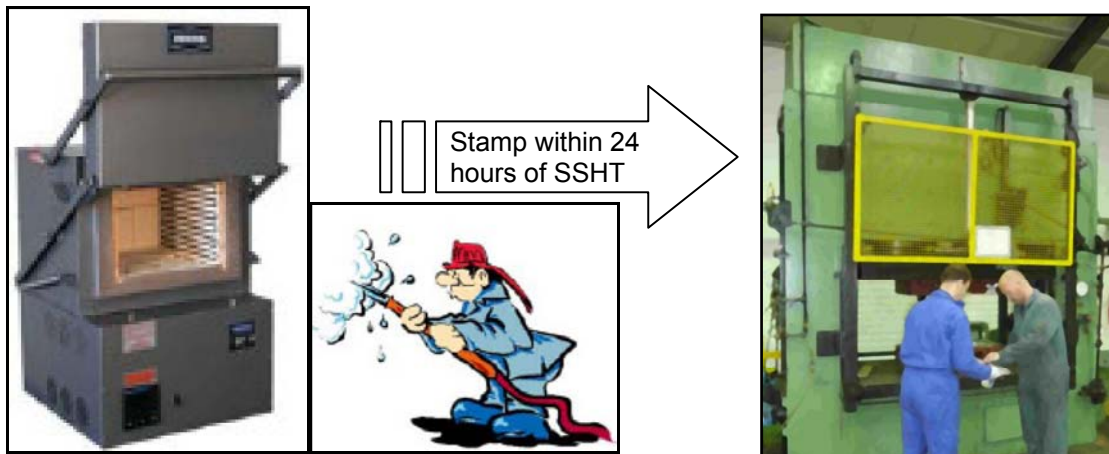

Crude SSHT process ($T \approx 450^{\circ}\text{C}$) followed by water quench ('W' temper)

Source: Aleris

This technique is envisaged for non-visible high strength aluminium alloys that are used in parts dimensioned by the strength requirements in the final part. The improved formability enables the realization of tighter forming radii, greater draw depths and part details in each forming step.

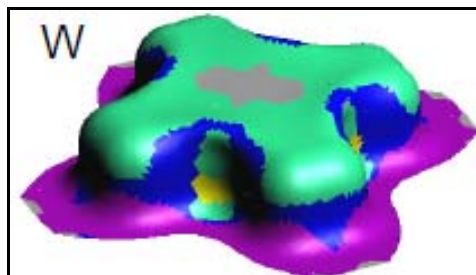

FE analysis result for a cross die test with 7xxx W (Fresh SSHT)

Source: Aleris

THE Aluminium Automotive MANUAL

A test with the cross tool demonstrates the improvement in draw depth that can be obtained using this technique with a high strength alloy.

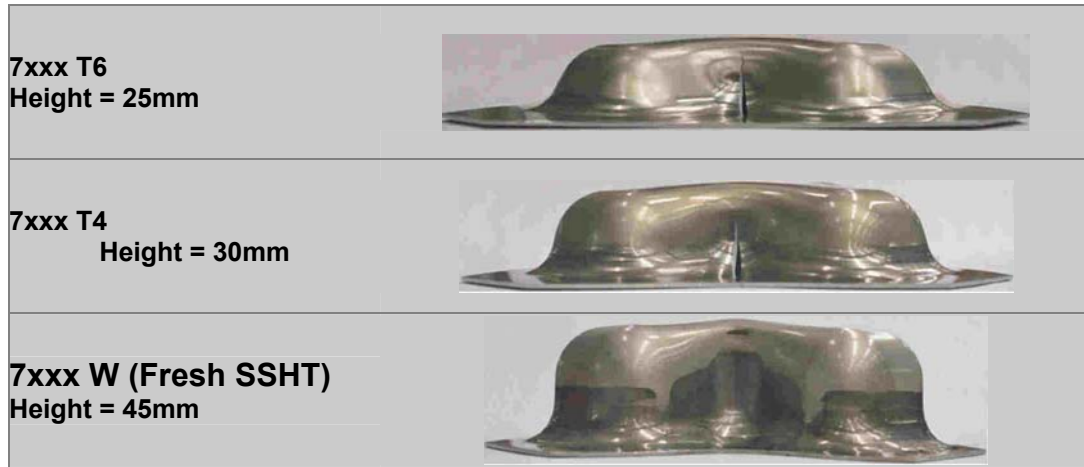

Deep drawing tests with a cross tool

Source: Aleris

In this case, the draw depth was increased by 50% without splitting (compared to the as-delivered 7xxx in T4 condition). An increased strength can be obtained by subsequent heat treatment processes, if required.

Advantages of SSHT & Ageing:	Disadvantages of SSHT & Ageing:
Increased depth of draw is possible compared to delivered temper of heat treatable alloys.	Additional process steps are needed
Potential to significantly upgrade and down gauge many simpler stampings with very little compromise on geometrical details.	Precise logistics are needed to ensure consistent stamping performance and final part strength.
Fewer draw operations. Some draw operations may be eliminated in certain cases.	
Reduced spring back	Higher energy consumption is required to perform SSHT process.
	The SSHT process described is sub-optimal so final strength is likely to be lower than as delivered material in T4 or T6 condition, if it can be stamped in the same tools.

An analogue effect is achieved in locally heat treated blanks. As an example, the local formability can be significantly improved in a specific region to realize tighter hemming radii. The local heat treatment is carried out by different methods, e.g. by the contact with a locally heated tool or by laser treatment.

Tailored blanks - Advanced processes enable cost-effective function integration

An efficient possibility to realise overall system cost savings and to reduce the weight of a specific component is the adjustment of the local material characteristics to the locally varying service requirements. Interesting solutions are offered by “tailored blanks”, i.e. sheet blanks consisting of different sheet alloy qualities and/or exhibiting variable material thicknesses. A locally varying material thickness can be produced within a sheet by a controlled variation of the roll gap (“flexible rolling”). Even more variations are possible when two or more sheets of different alloy composition, sheet thickness and/or shape are combined to a single piece by welding (“tailor welded blank”). Selected joining technologies like friction stir welding, laser welding or electron beam welding lead to a seam quality which enables - within limits and using properly designe tools - the subsequent part production by forming. When fusion welding processes are used, the addition of an appropriate filler metal must be considered, depending on the specific alloy combination. Linear and non-linear tailor welded blanks or so-called “patchwork blanks” where the sheet pieces are laid on top of each other open a wide range of possibilities for the development and introduction of new, innovative design concepts..

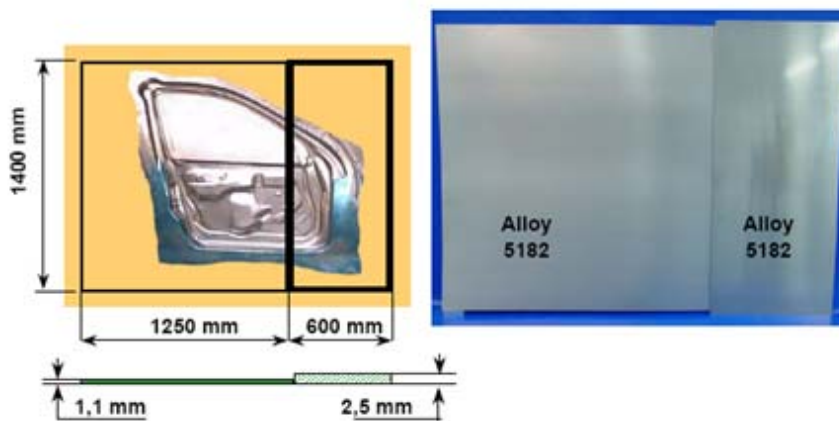

Friction-stir welded blank for a door inner panel

Source: Aleris

Tailored blanks (used both for steel and aluminium) offer the potential for functional integration into sheet products:

Advantages:	Disadvantages:
Improved stiffness and fatigue strength	Process cost (laser / friction stir welding and variable thickness rolling operations)
Reduced geometrical offset at transition of thickness or materials improves stability during in-plane loading	Increased complexity of stamping tools and processes (step in tooling to accommodate thickness change, blank stacking considerations, more complex draw behaviour and the need to model and monitor the movement /straining of the transition)
Weight reduction from elimination of overlapping material at transition of thickness or materials	
Tighter tolerances compared to assemblies	
Reduced assembly cost	

4.4.3 Components made from extruded sections

The right solution depends on the envisaged production volume

An important factor determining the design economics are the investments in product development, product verification and validation, tools and equipment. Clearly, the volume to be produced influences the acceptable level of these investments.

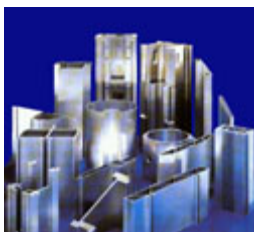

It can be very profitable to invest time and effort in product development using numerical simulation techniques to obtain optimum product properties in order to save some few percentage of weight when the total number of parts is high (e.g. > 1 mio.).

For small series production, the optimising strategy might be different. The same philosophy applies to the other investments related to product manufacturing. Extruded profiles for low volume applications are typically not formed into complex shapes as this would mean investing in tools, which cannot be amortised on the parts price when there are lower cost alternatives. In this case, the alternative would typically be more machining and joining/assembly operations.

Small production volumes (10 – 1000): Use standard profiles (simple, standardized cross sections).

Low production volumes (1000 – 10 000): Use of specifically designed (“tailored”) profile cross sections, dedicated extrusion tools, 2D forming in simple tools, simple machining (cutting, drilling) and/ or punching.

Medium production volumes (10 000 – 100 000): Use of weight optimised, specifically designed profile cross sections, dedicated extrusion and forming tools, standard presses and equipment, punching instead of machining.

High production volumes (>100 000): Highly optimised extrusion product, dedicated forming tools (bending, hydroforming), punching – very little machining, possibly invest into dedicated machines and equipment.

The cost of scrap generation and its re-use makes the supply of near-net shape parts (prefabricated extrusions) attractive. The production of ready-for-assembly parts by the aluminium suppliers also allows them to manage scrap and its recycling more effectively.

Integrate functions with extrusions

Unlike other forming and shaping processes, the aluminium extrusion technology enables the production of shapes in fairly complex geometries in a single operation. As a result, the designer is able to position the metal where it is most effective and to combine and incorporate complementary functions into the individual components while at the same time saving weight:

- increase the stiffness of the structure,
- facilitate assembly operations,
- reduce the required amount of machining.

The examples shown in the following figures illustrate some of the advantages presented by aluminium alloy extrusions compared with conventional steel solutions. The steel section in fig. 1 is obtained by roll forming a longitudinally welded tube. It is superseded by an aluminium shape whose stiffness is provided by an additional inner wall. A lug is added to facilitate connection to another component, e.g. a car body panel. The finned steel tube in fig. 2 would probably be made by welding fins onto a round tube, whereas it can be directly extruded in an aluminium alloy.

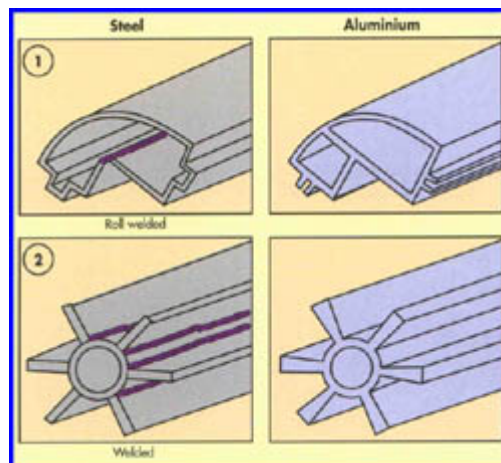

Replacement of complex steel sections by simple aluminium extrusions

The ability to accurately produce shapes with fine details minimises the need for additional machining (fig. 3). A shape with a cross section of the type shown in fig. 4 which is made by folding and welding steel strip is produced in aluminium directly in the extrusion process.

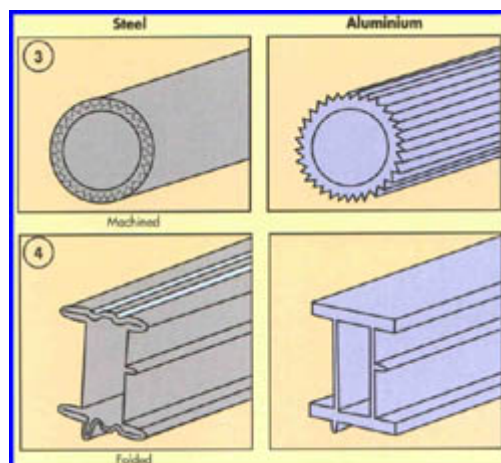

Cost-effective substitution of steel sections by aluminium extrusions

THE Aluminium Automotive MANUAL

Extrusions offer many ways of combining functions that reduce the cost of assemblies and optimise the use of material. Extrusion tools (dies) are modest in price, making aluminium extrusions a very attractive solution, even for low production volumes.

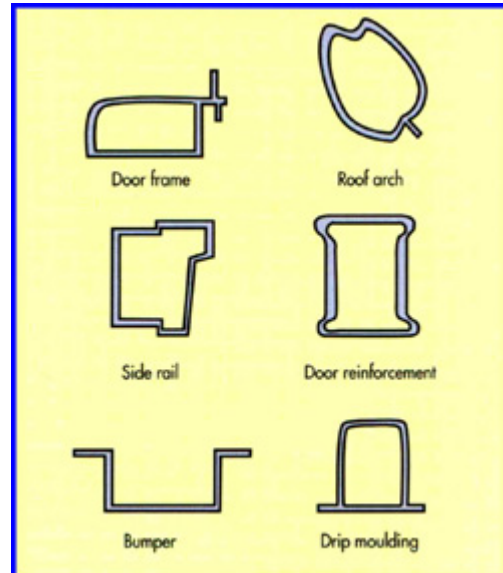

Examples of integration of functions in extrusions

The selected examples demonstrate the availability of complex geometrical shapes that require little or no fabrication and which can do the work of several components joined together while providing a substantial saving in weight at the same time.

Design guidelines for aluminium extrusions

The whole manufacturing and production process starts with the design. In the design phase, extrusion takes shape and features are built in to reduce weight, simplify assembly, add functionality and minimise finishing costs.

a) Wall thickness

Strength and optimum cost-efficiency are the two main considerations when the wall thickness of a profile is determined. Extrusions with a uniform wall thickness are easiest to produce. However, the wall thickness within a profile can also be varied easily. For example, the bending strength of a profile can be increased by concentrating weight/thickness away from the centre of gravity.

b) Cost-efficient production

For cost-efficiency, the design of an extrusion should be as production-friendly as possible.

Thus, the profile should:

- have a uniform wall thickness
- have simple, soft lines and rounded corners
- be symmetrical
- have a small circumscribing circle
- not have deep, narrow channels.

An important parameter is the applicable minimum wall thickness. The factors which have an effect on the wall thickness are extrusion force and speed, the choice of alloy, the shape of the profile, desired surface finish and tolerance specifications.

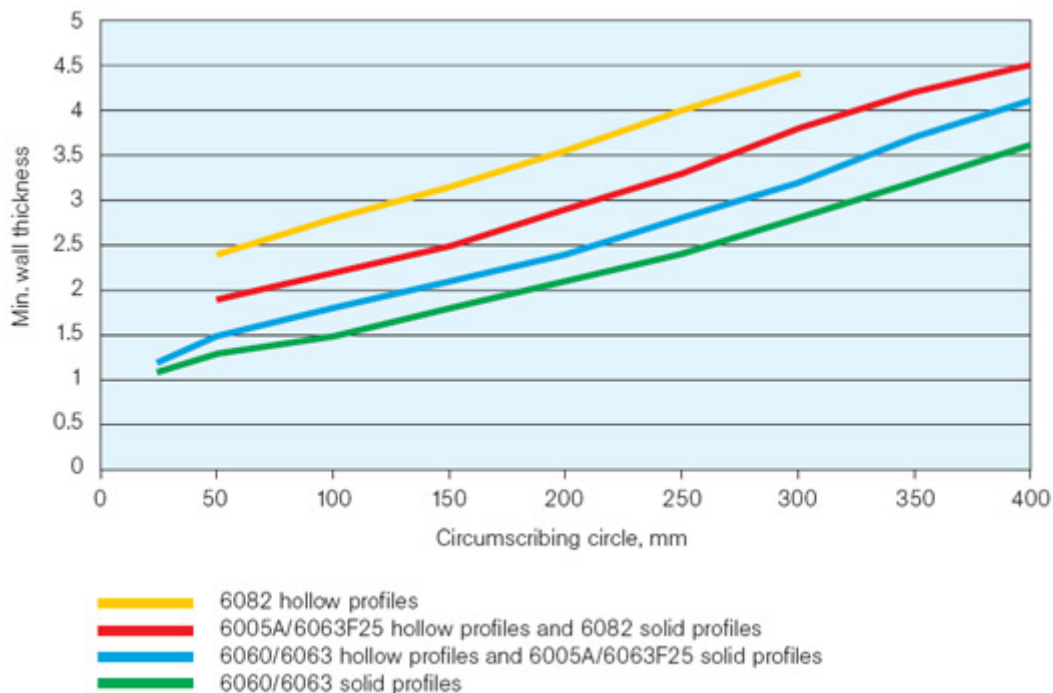

Suggested minimum wall thickness for cost-efficient extrusions

Source: Sapa

The extrusion process cannot achieve razor-sharp corners without additional fabrication. Corners should be rounded. A radius of 0.5 – 1 mm is often sufficient. Also in many cases, reducing the number of cavities in a hollow profile makes it easier to extrude. For profiles with pockets or channels, there is a basic rule that the width to height ratio should be approximately 1:3. By using large radii at the opening of the channel, and a full radius at the bottom, the ratio

can be increased to 1:4.

Bending of aluminium profiles

The need for bending should be taken into consideration at the design stage. When planning a profile bending operation, the alloy, temper and cross section of the extrusions must be taken into the account. Deformation of the inside or outside radii can also be a design issue and determines which forming process to use. Before beginning the design process, it is necessary to consider:

- What tolerances are expected on the inside, the outside dimension radius, and the overall length of the part?
- What surface areas are critical for appearance?
- What mechanical strength is required?

Aluminium extrusions can be bent using the same equipment as for other metals. For larger radii, bending can take place with age hardened alloys but smaller radii usually require bending in the soft annealed or T4 (half-hardened) temper. It is possible to harden the extrusions to full strength after bending.

There are different bending methods in practical use, some examples:

a) Press bending

Press bending (point bending, push bending) is suitable for simple bending of large series. The work piece is formed using compressive force. An upper and a lower die are contoured to give the work piece the desired shape. Pressure is applied by some form of eccentric or hydraulic press. It is a controlled, programmable, single axis bending process which can perform close proximity multiple plane bends. However, only one radius can be bent at a time.

Depending on the exterior of the part to be pressed, dies can be steel or plastic. Press bending offers good bend precision with low per-bend cost, the tooling is fairly inexpensive.

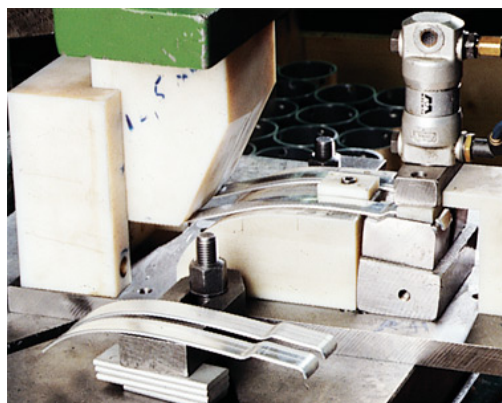
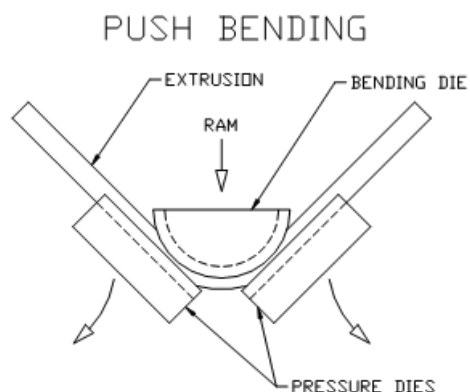

Press bending of aluminium extrusions

Source: Sapa

b) Rotary draw bending

Draw bending is the most commonly used bending method with moderate tooling cost. It is suitable for tight radii and has a high degree of repeatability. Using an adjustable clamping jaw, the work piece is fixed against a rotating die. The clamping jaw and the tool are shaped

THE Aluminium Automotive MANUAL

to reproduce the cross section of the profile. The work piece rotates with the die. This stretches the material on the outside of the profile and compresses that on the inside. In order to prevent scratches and clamping marks on the profile, the tools are usually made of plastic.

In its simple (hydraulic) variant, only one radius can be bent at a time. Bending can be carried out with or without mandrel. Rotary draw bending is a single axis controlled bending process with 90° maximum bend per bend. The bend precision is good (resolution to 0.1°), the equipment is not portable.

In its more complex (electric) variant, the rotary draw bending process offers a faster setup and more accurate and repeatable bending. Multiple axis PLC controlled operation allows very accurate bends and movements, the bending precision is excellent. Rotations are automatic for variable plane bends. The application of this bending technique is beneficial for:

- Numerous bends per part
- Bends which are in close proximity to each other
- When multiple bend radii are needed on the same part
- Bends which are out of plane on round parts
- When both small and large radius bends are required.

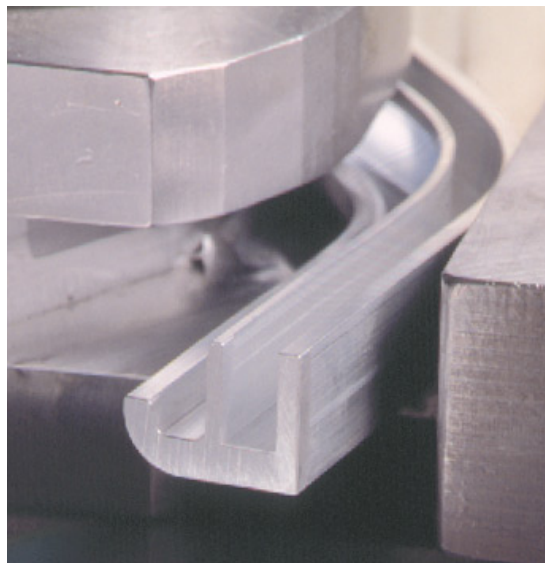
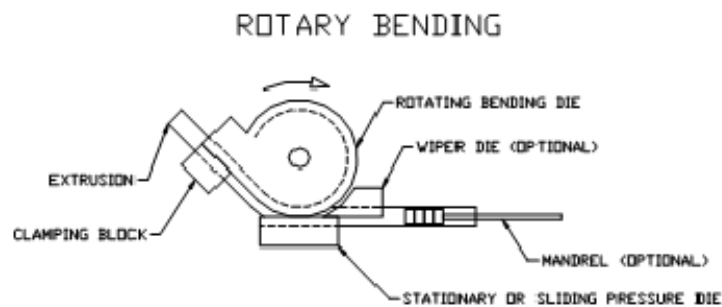

Rotary bending of aluminium extrusions

Source: Sapa

c) Roll bending

Roller bending is used for forming large radii in the work piece. The work piece is rolled between two drive rollers and a pressure roller. The shape presented by the rollers corresponds to the profile's cross section. Vertical adjustment of the upper roller (the pressure roller) alters the radius of the bend. Thus, in CNC machines, a number of different radii can easily be pressed into a single work piece.

As rollers are most usually made of steel, lubrication is often required to prevent cutting and scratching of the profile.

Roll bending is another moderate tooling cost method; however, only relatively large bending radii are possible. The method can roll horizontally or vertically, but is limited to single plane bending per cycle. The maximum bend radius is unlimited; the bend precision is very good. This process is most suitable for symmetric profiles.

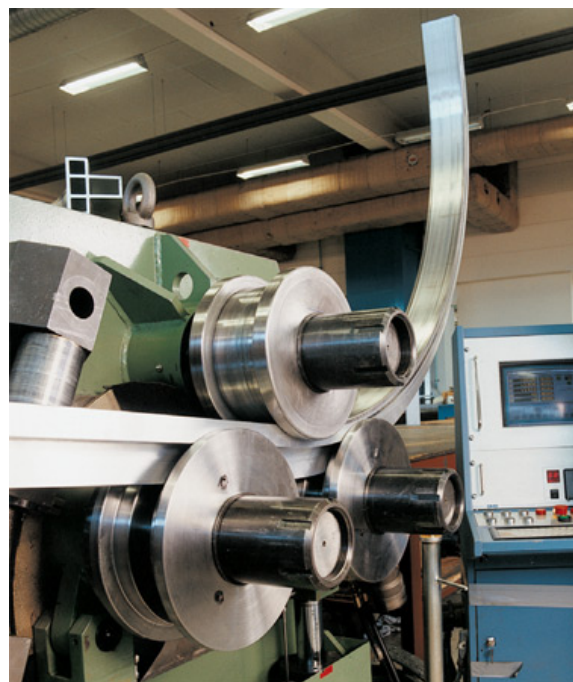
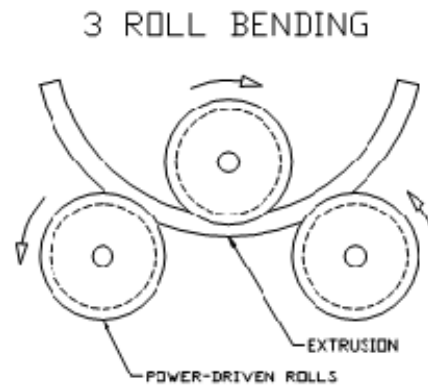

Roll bending of aluminium extrusions

Source: Sapa

d) Stretch forming

Stretch bending gives very high three-dimensional shape accuracy and consistency with high to medium per-bend cost. It can bend, twist and lift the profile simultaneously. The work piece is fixed between two clamping jaws and then gradually stretched over a shaping block. The shape presented by the block corresponds to the cross-section of the profile. The metal is stretched to its upper elastic limit and spring-back is thus negligible. Also non-symmetric profiles are readily formed without twist and minimal surface distortion and damage. The maximum bend radius is unlimited; the minimum bend radius is generally 2-3 times greater than other forming/bending methods.

As the tooling investment is relatively high (higher than other forming/bending methods), stretch bending is best suited to large series production. The bend radius cannot be modified without additional tooling charge.

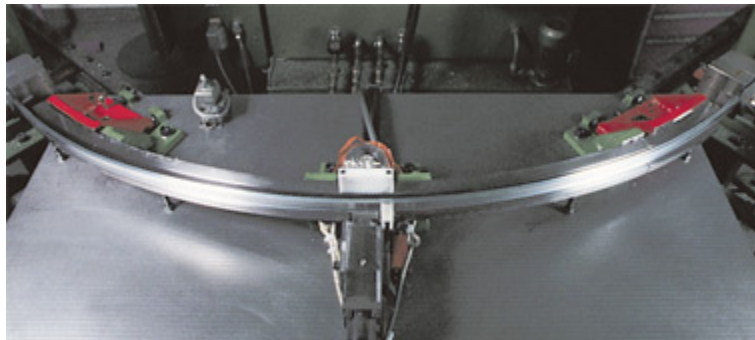
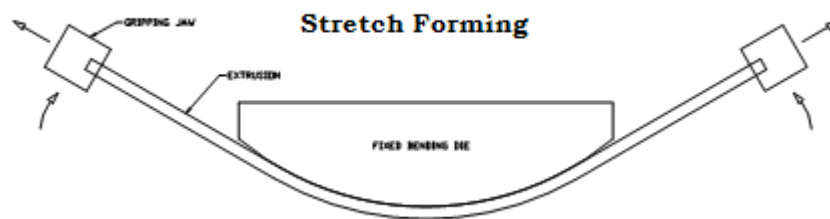

Stretch bending of aluminium extrusions

Source: Sapa

Hydroforming

The application of the hydroforming process allows shaping an aluminium profile three-dimensionally in a single operation. In fact, hydroforming opens the way to unique solutions for a wide range of design problems.

Hydroforming is in principle a relatively simple technology, but requires large hydraulic presses and sophisticated tooling. Thus it is mainly suited for large series production, although the processing time (typically 0.5 – 1 min) limits the production volume. An extruded profile is placed in a die that has an inner geometry exactly replicating the shape of the finished component. The die is locked securely in position and hydrostatic pressure is then set up in the pipe (profile). As the profile is pressed against the die, it takes up the shape of the die.

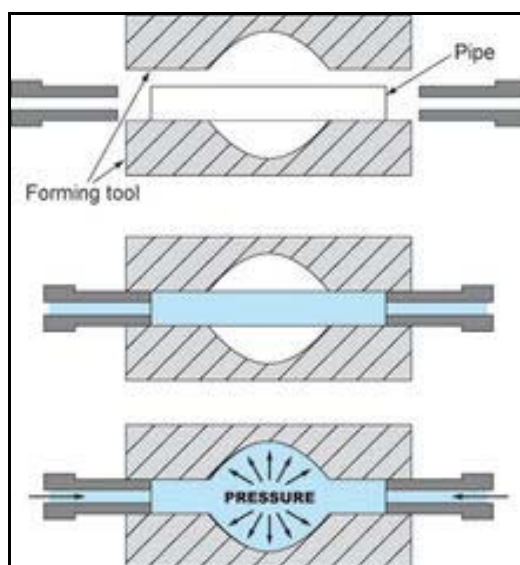

Tube Hydroforming

Source: Design Light AB

A big advantage of the hydroforming process is the high geometrical accuracy of the final part. Therefore, hydroforming is often used also as a calibrating operation for preformed (e.g. bent) extrusions. Aluminium tubes may be extruded with internal features and variable wall thickness around the section. This may, however, increase the complexity of pre-forming the blank, of correctly positioning the blank in the tooling and may limit the shaping capability available from the hydroforming process. Thus, extruded one chamber aluminium profiles with a relatively simple cross section or round tubes will be mainly used for the most demanding hydroforming operations.



Hydroformed aluminium tube

Source: Sapa

THE Aluminium Automotive MANUAL

The process offers as yet unexplored possibilities, in particular since it also enables the integration of other fabrication processes such as punching of holes, flange and end cutting operations, etc. In a single operation, complex parts can be created with very good dimensional accuracy. All or parts of the cross section of a profile can be formed using hydroforming. In a single hydroforming operation, it is also possible to make local changes such as domes or indentations. By eliminating several machining operations, total lead times can be shortened.

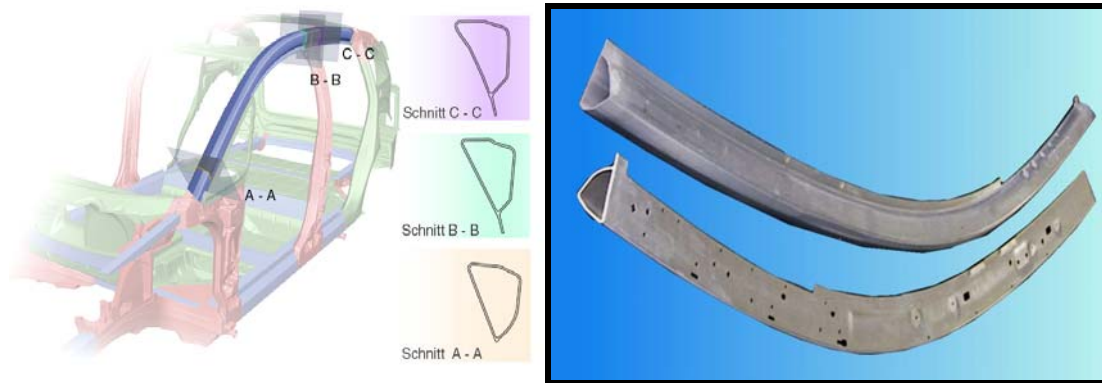

Hydroformed aluminium roof rail integrating all the various fabrication operation into a single forming step

Source: Audi

Some advantages and disadvantages of the tube hydroforming process are outlined below:

Advantages for tubular applications:	Disadvantages for tubular applications:
Re-entrant (under-cut) geometrical features possible.	High Cycle time / process cost
Punched holes with little distortion of tube surface	Expensive specialised equipment
Tight geometrical tolerances	Wet environment
Reduced thinning near ends of tube if end feeding used	Pre-forming or pre-bending may be necessary for blank to fit into die
Reduced spring back.	Often need to trim off tube ends that served as seal surfaces.
	Not recommended for visible surfaces

Finishing operations

a) Sawing

Most aluminium alloys allow far greater sawing speeds than applicable with steels and in most cases, sawing is an economic and very advantageous solution. Aluminium extrusions can be sawn accurately without the formation of burrs. The required appearance of the cut, the alloy used and the extrusion's strength determine the size of the teeth, the number of revolutions per minute, the number of teeth, the diameter of the blade and the feed. The number of teeth should be sufficiently large to give a clean cut effectively. When sawing thin extrusions, several teeth should always cut into the material and cutting lubricant should always be used.



Sawing of aluminium extrusions

Source: Sapa

b) Deburring

Deburring is a process for removing small chips and any remaining burrs on the extrusion cut. The most common deburring method is mechanical using a brush or a grinding machine. Abrasive tumbling, where fragments are removed by friction using circulating stones, is a suitable method for deburring small and medium sized parts.

c) Milling

Milling machines for the fabrication of aluminium have larger teeth pitches than equivalent tools for steel and therefore a more spacious groove for chips. As for sawing, a high cutting speed is required for a good result. A high quality of the milled surface demands high power and stability in the tool and feed mechanism.

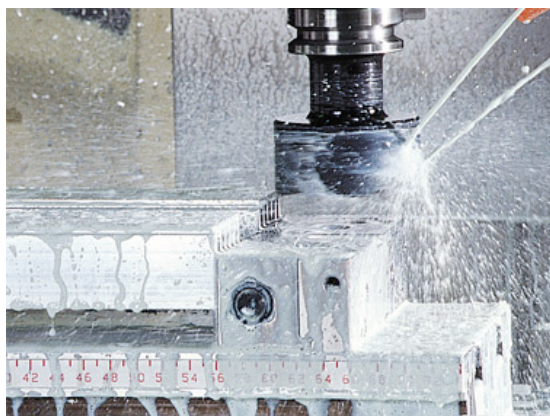

Milling of aluminium extrusions

Source: Sapa

d) Drilling

As with most machining, drilling should be carried out at a high speed. Special bits for aluminium are only required for deep holes or soft alloys. It is important to note that the hole will be considerably larger than the bit diameter when drilling in aluminium, especially when drilling in soft alloys. A significant amount of heat is generated when drilling deep holes, especially if the diameter is large. Cooling is therefore essential to avoid contraction of the holes.



Drilling of aluminium extrusions

Source: Sapa

e) Turning

Aluminium can be turned in standard, special and automatic lathes. Turning should be carried out at high rotation speeds. Parts to be turned must therefore be fitted securely to avoid any vibration. Spacers between the part and the mounting prevent marks on the metal or deformation of the part.

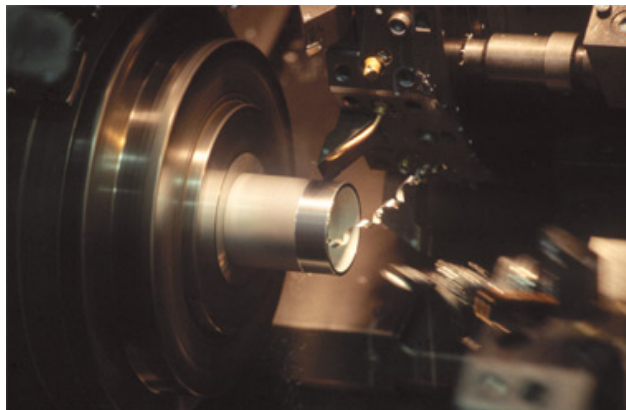

Turning of aluminium extrusions

Source: Sapa

f) Threading

Internal and external threads can be made using all available machining methods as well as through plastic deformation. Taps for steel can be used for threads under 6 mm, but special taps should be used for larger diameters. Internal threads can either be made with taps in series or with a single tap. The groove for chips should be large and wide, well rounded and polished as well as have a large cutting edge angle.



Threading of aluminium extrusions

Source: Sapa

External threads are made using ordinary threading tools or screw cutting dies. The threads can also be formed plastically by rolling without any forming of chips. This creates a very strong thread. The external diameter of the part to be threaded should be 0.2 to 0.3 times the size of the screw pitch compared to the nominal thread diameter. It is very important that the centre lines of the metal part and the tool are aligned.

g) Shearing

Press work is normally carried out in eccentric presses with a cutting (shearing) tool. The press tools for aluminium are slightly different from those designed for other metals. Punch and die of hardened tool steel are recommended. It is important to maintain the correct clearance between the punch and the die during the actual cutting process. The clearance is determined by the material's composition and the thickness of the cut material.



Shearing (pressing, punching) of aluminium extrusions

Source: Sapa

4.4.4 Cast solutions

Introduction

Castings as one-piece components can replace sub-assemblies that consist of a number of welded or machined parts. Generally speaking, components should be transposed on the basis of functions to be provided and constraints of space, and by disregarding the geometry of all existing solutions. The functionality of aluminium castings is a long established fact in powertrain applications where they combine a multiplicity of functions. Castings can also help to improve the fatigue strength of structural parts while either reducing the number of welded assemblies or positioning them more favourably.



Rear cradle prototype designed for Audi A8

The aluminium rear subframe shown above consists of a casting that combines all the functions of ribbings, caps and other attachment points, and a drawn sheet of simple design that closes the casting. Its fatigue strength is considerably improved over a straight transposition because it eliminates welds for the attachments and moves the weld line of the two parts into zones of lower stress. This new design reduces the number of connections and is ideal for use on production lines. It also offers a 35% weight saving.

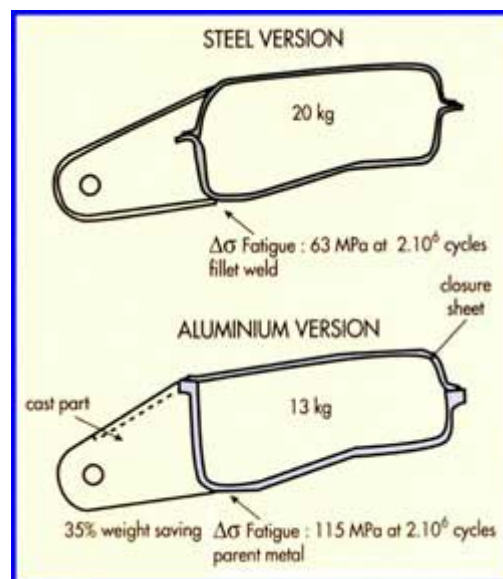

Fatigue design of Audi A8 rear cradle prototype

: Many different aluminium casting processes are used in practice to produce automotive castings. Thus, it is not possible to provide specific design guidelines for each process variant. In the following, only two processes will be considered in more details: sand casting and high pressure die casting.

Selection of alloy and casting process

Many different casting methods and alloys can be used to produce a wide variety of aluminium components. The choice of alloy and casting process determines both the properties of the resulting component and the fabrication cost. There are three major factors that drive the quality and cost of a cast aluminium component – functionality (service requirements), design (shape and size) and production quantity. Each of these factors will have a large influence on the choice of the casting method, the alloy selection and the cost, as well as the final component quality.

a) Functionality and service requirements

Choosing the alloy, casting process and thermal treatment requires knowledge of the service conditions of the proposed part, so defining the end-use functions and requirements is always the starting point. If high-strength, safety-critical components are required, the number of potential casting processes is narrowed, and a high-integrity casting process, such as premium sand casting, vacuum-assisted high pressure die casting or semi-solid casting process, will be chosen. Also the alloy selection cannot be made until the component's end-use requirements are defined. The range of possible mechanical properties varies widely because there are many alloy and thermal treatment combinations.

b) Design

Once the function of the desired component is determined, design issues such as size, weight and part complexity can be considered. The size and design features of the casting and the available alloys can drive the choice of the casting process and the cost of the component. Sand casting often is used to produce parts with hollow cavities and a complex arrangement of ribs and pockets that make them less suitable for casting in permanent molds. On the other hand, it might be advantageous to redesign a casting for a lower cost process, such as permanent mould or high pressure die casting. In some cases, the finished component cost can be reduced by including features in the design that will produce a near net-shape cast part and eliminate or minimize additional costs from subsequent finishing processes, such as machining.

Regardless of cost, the process choice might be limited by the size of the component. For example, for large or heavy castings, sand casting may be the only option. Although this process typically requires lower tooling costs, the unit price of the castings and the finished part can be high. Permanent mold casting has higher tooling costs, but the unit price is lower, particularly for higher quantities. Die casting has the highest tooling cost, but also the lowest piece price on large quantities.

c) Production quantity

Another critical factor which determines the selection of the casting process selection and cost is the production volume. Permanent mould casting, die casting or automated sand casting processes can be used to produce high quantities if the size and design features of the component and the available alloys are suitable. However, the tool cost for permanent mould and die casting are high, thus large production quantities are required to justify the tooling costs. If low-quantity parts and large castings are required, the best option is sand casting, which offers the lowest tooling cost with the capability to cast large components.

d) Aluminium casting metallurgy

The specification of an aluminium alloy for a cast component is based upon the envisaged mechanical properties. The properties of an aluminium casting result from three primary factors: the alloy composition, the melting and casting operation, and the final thermal treatment.

e) Aluminium processing

Molten aluminum has several characteristics that can be controlled to maximize the quality and the cast component. It is prone to picking up hydrogen gas and oxides in the molten state

as well as being sensitive to minor trace elements. Tight melt control and specialized molten metal processing techniques provide enhanced mechanical properties when required.

Design guidelines for aluminium sand castings

The sand casting process includes basically six steps:

1. Place a pattern in sand to create a mould
2. Incorporate the pattern and sand in a gating system
3. Remove the pattern
4. Fill the mould cavity with molten metal
5. Allow the metal to solidify
6. Break away the sand mould and remove the casting.

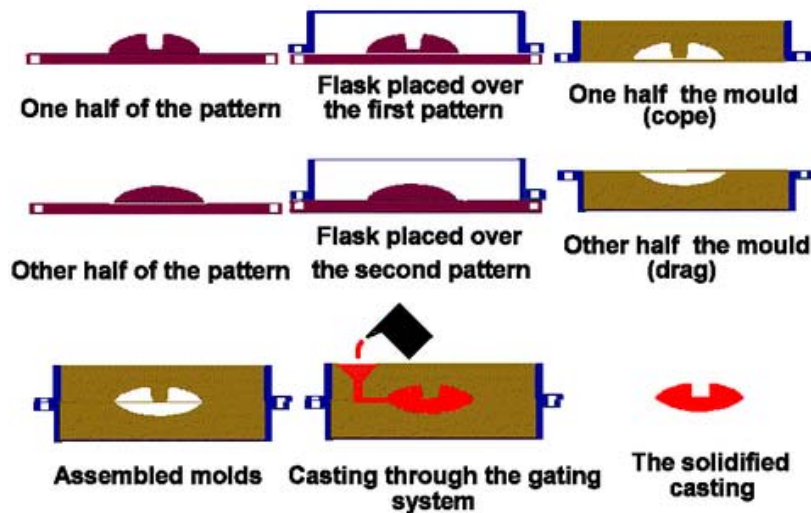

Basic steps of the sand casting process

In order to control the solidification structure of the metal, it is possible to place metal plates (chills) into the mould. The associated rapid local cooling will form a finer-grained structure and may thus improve the local mechanical characteristics. Chills are also used to promote directional solidification within the casting. By controlled solidification, it is possible to prevent internal voids or porosity inside castings.

To produce cavities within the casting, negative forms are used to produce cores. Usually sand-moulded, these cores are inserted into the casting box after removal of the pattern. Whenever possible, designs are made that avoid the use of cores, due to the additional set-up time and thus greater cost.

The part to be made and its pattern must be designed to accommodate each stage of the process, as it must be possible to remove the pattern without disturbing the moulding sand and to have proper locations to receive and position the cores. A slight taper (draft) must be used on surfaces perpendicular to the parting line in order to be able to remove the pattern from the mould. This requirement also applies to cores, as they must be removed from the core box in which they are formed. The sprue and risers must be arranged to allow a proper flow of metal and gasses within the mould in order to avoid an incomplete casting. Gas pockets can cause internal voids.

After casting, the cores are broken up by rods and removed from the casting. The metal from the sprue and risers is cut from the rough casting. Various heat treatments may be applied to relieve stresses from the initial cooling and to increase strength and/or ductility. The casting may be further strengthened by surface compression treatment (e.g. shot peening) that adds resistance to tensile cracking and finishes the rough surface.



Sand cast rear control arm

Source: GF Automotive

The thin-walled sand cast rear control arm shown above with a weight of only 2.6 kg is an example for an extremely lightweight solution. It is used in the Audi models A4, A5, Q5 and A8 (alloy: AlSi7Mg).

Design guidelines for aluminium die castings

Die castings are among the highest volume, mass produced items manufactured by the casting industry. For aluminium, cold chamber machines are generally used. A precise amount of molten metal is transferred from the furnace to the die casting machine where it is fed into an unheated shot chamber (or injection cylinder). This shot is then driven into the locked die at high pressures by a hydraulic or mechanical piston where it solidifies rapidly.

Two dies are used in die casting; one is called the "cover die half" and the other the "ejector die half". Where they meet is called the parting line. The cover die contains the shot hole, which allows the molten metal to flow into the dies; this feature matches up with the shot chamber. The ejector die contains the ejector pins and usually the runner, which is the path from the shot hole to the mold cavity. The cover die is secured to the stationary platen of the casting machine, while the ejector die is attached to the movable platen.

The dies are designed so that the finished casting will slide off the cover half of the die and stay in the ejector half as the dies are opened. This assures that the casting will be ejected every cycle because the ejector half contains the ejector pins to push the casting out of that die half. Other die components include the cores and the slides. Cores are components that usually produce holes or openings, but they can be used to create other details as well. Fixed cores are ones that are oriented parallel to the pull direction of the dies (i.e. the direction the dies open), therefore they are fixed to the die. Movable cores are ones that are oriented in any other way than parallel to the pull direction. These cores must be removed from the die cavity after the shot solidifies, but before the dies open, using a separate mechanism. Slides are similar to movable cores, except they are used to form undercut surfaces. The use of movable cores and slides greatly increases the cost of the dies. Other features in the dies include water-cooling passages and vents along the parting lines. The vents are usually wide and thin so that when the molten metal starts filling them the metal quickly solidifies and minimizes scrap. No risers are used because the high pressure ensures a continuous feed of metal from the gate.

The most important material properties for the dies are thermal shock resistance and resistance to softening at elevated temperature; other important properties include

machinability, heat checking resistance, weldability, and cost. The dies used in die casting are usually made out of hardened tool steels, resulting in high start-up cost.

a) Draft

Draft is the amount of taper or slope given to cores or other parts of the die cavity to permit easy ejection of the casting. All die cast surfaces which are parallel with the opening direction of the die require a certain draft (taper) for proper ejection from the die. This draft requirement, expressed as an angle, is not constant. It will vary with the type of specified wall, the depth of the surface and the selected alloy. When proper draft is applied, it is much easier to open the die and to eject the casting resulting in a more precise cast part with higher surface quality.

b) Fillets and parting line

A fillet is the curved juncture of two surfaces that would otherwise meet at a sharp corner or edge. While modelling a part all sharp corners and edges should be filleted. Only the parting line where the two halves of the casting die meet on the part geometry should be left sharp.

c) Bosses

Bosses are often added to parts e.g. to act as mounting points. It is critical to maintain uniform wall thickness in a boss feature and therefore, a hole is almost always added to the middle of the boss. In addition, draft is required on the outer and inner surfaces of the boss. Bosses may be difficult to fill, as it is hard for molten metal to flow up a tall narrow boss feature.

d) Ribs

Ribs are often added to increase strength in specific regions of a part. The major advantage of ribs is that they can add strength without increasing the typical wall thickness of a die cast part. The resulting part design is lighter and uses less material, but still has the required strength. Ribs also assist in providing molten metal flow to part features that would otherwise be difficult to fill. However it should be kept in mind, in some applications ribs may not be necessary and will only add unneeded complexity to the part and die design.

e) Holes and windows

Considering the effect on molten metal flow through the part, it becomes clear that hole and window feature configurations play an important role in the manufacturability and final quality of a die cast part. Holes and windows may also have an effect on ejection of the part from the die as the perimeter of these features will grip onto the die steel during solidification. To counteract this gripping action, generous draft should be added to hole and window features. Molten metal flow may be blocked by through holes and windows. However; with the addition of bridge like cross feeders or overflows to the die casting die, the flow across through windows and holes can be re-established.

f) Uniform walls

There are no hard rules governing maximum and minimum limits for wall thicknesses. The wall thickness should be as uniform as possible throughout the component and, where variations are required, transitions should be provided to avoid abrupt changes. However, the production of castings with extreme maximum and minimum wall thicknesses and with wide variations are possible using high-technology equipment and sophisticated casting techniques. This capability should be utilized only as necessary to achieve performance or economic advantages otherwise uniform wall thicknesses are preferred.

g) CAD feature order

One of the most common challenges in creating a parametric model of a die casting design is creating features in an order that allows for changes without creating errors in the feature tree. In addition, creating as-cast and machined versions of the model may be difficult or time consuming. The method for ordering CAD features presented in the following eliminates or greatly reduces feature tree errors and eases the development of a die casting design model:

1. Base geometry features: Features such as extrusions, bosses, cuts, shells, etc., that make up the basic geometry of the model should appear at first at the top of the feature tree.

THE Aluminium Automotive MANUAL

2. Cast cored holes: Next as-cast cored holes should appear. These are holes that will be cast during the die casting process and may or may not be machined or tapped later.
3. Parting lines: Parting lines, if needed, should be next. Some castings will have a natural parting line that will appear after draft has been applied to the part.
4. Draft: Draft application should be next.
5. Fillets: Next fillets should be added to all geometry. In some cases, fillets will not be added to the parting lines.
6. Machining: Finally, all machined features should be added. By having the machined features at the end of the feature tree, they can be suppressed and un-suppressed creating an as-cast and machined part model very quickly. Adding machined features last also makes it much easier to determine the amount of as-cast geometry required to provide the correct amount of machining stock.

Creating as-cast and machined part model configurations is an excellent way to clearly convey what features should be as-cast and what features should be machined. In addition, creating separate drawings for as-cast and machined parts will be simplified by using this method.



B pillar of the Audi A2 produced by vacuum-assisted high pressure die casting (as-cast and final shape)